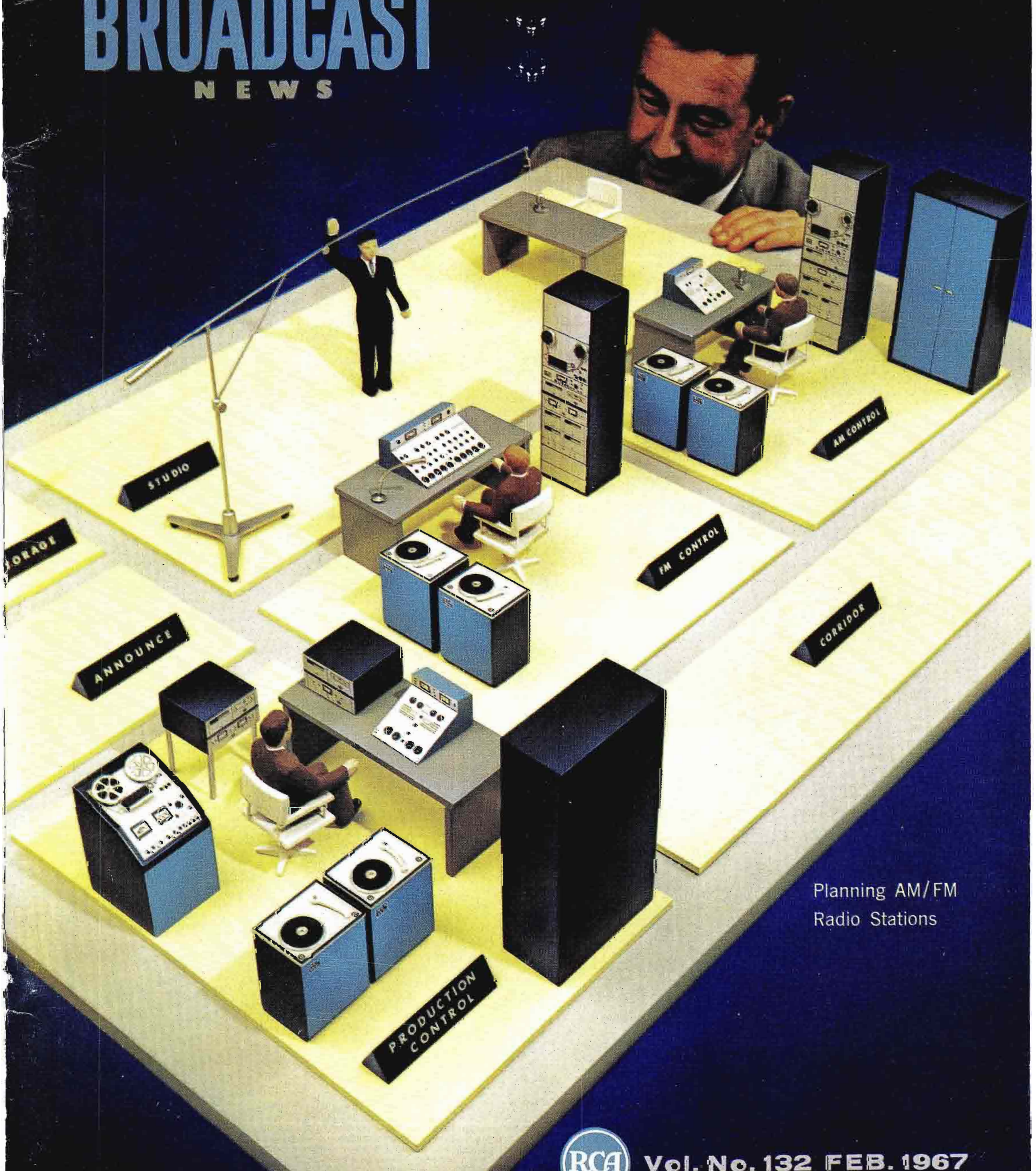


# BROADCAST NEWS



Planning AM/FM  
Radio Stations



Vol. No. 132 FEB. 1967



**For assistance in planning  
and equipment... see your  
RCA Broadcast Representative**

Atlanta, Ga. 30303  
1121 Rhodes Haverly Bldg.  
134 Peach Tree St., N.W. 404-524-7703  
**P. G. Walters**

Austin, Texas 78756  
Northwest Professional Bldg.  
5425-B Burnet Rd. 512-453-8233  
**J. N. Barclay**

Birmingham, Ala. 35223  
Office Park Bldg. #10  
Office Park Circle 205-871-1155  
**J. Smith**

Boston: West Newton, Mass. 02165  
950 Watertown St. 617-969-6010  
**E. H. Herlihy**

Burbank, Calif. 91505  
2700 W. Olive Ave. 213-849-6741  
**E. J. Frost • M. Ellison**

Camden, N. J. 08102  
Front & Cooper Sts. 609-963-8000  
**J. A. Gimbel**

Charlotte, N. C. 28204  
330 Charlottetown Center 704-333-3996  
**R. M. Williams**

Chicago, Ill. 60654  
Merchandise Mart Plaza,  
Rm. 2000 312-467-5900  
**D. C. Borchert • F. A. Timberlake**

Cincinnati, Ohio 45224  
8234 Winton Rd. 513-522-8810  
**C. E. Raasch**

Cleveland, Ohio 44115  
1600 Keith Bldg. 216-241-3450  
**W. C. Wiseman**

Dallas, Texas 75235  
210-C Court Terrace  
Exchange Park, N. 214-351-5361  
**G. McClanathan • E. H. Hoff**

Denver, Colo. 80211  
2785 N. Speer Blvd.,  
Suite 223 303-477-6832  
**R. F. Goodspeed**

Detroit: Southfield, Mich. 48076  
20830 Rutland Ave. 313-357-0080  
**W. P. Happel**

Indianapolis, Ind. 46201  
501 N. LaSalle St. 317-635-9000  
**R. Mele**

Kansas City, Mo. 64114  
7711 State Line Rd.  
Suite 112 816-363-6770  
**V. S. Mattison**

Memphis, Tenn. 38114  
2110 Airways Blvd. 901-743-9442  
**B. E. Fincher**

Minneapolis, Minn. 55416  
4522 Excelsior Blvd. 612-922-3303  
**W. G. Eberhart**

New York, N. Y. 10020  
30 Rockefeller Plaza  
Rm. 1219 212-689-7200  
**O. E. Wagner • R. F. Varda  
J. R. Sims**

Pittsburgh: Meadow Lands, Pa. 15347  
Washington County 412-341-5294  
**D. P. Allen**

San Francisco, Calif. 94104  
343 Sansome St.  
7th Floor 415-956-4818  
**M. M. Corbett • R. J. Newman**

Seattle, Wash. 98134  
2246 First Ave., S. 206-622-8350  
**R. Harding**

St. Louis, Mo. 63105  
7710 Carondelet Ave. 314-862-3660  
**D. B. Freeman**

Washington, D. C. 20006  
1725 "K" St., N.W. 202-337-8500  
**O. J. McReynolds**

West Palm Beach, Fla. 33403  
3900 Monet Rd.  
Palm Beach Gardens  
305-844-7351, Ext. 2891  
**R. E. Giles**

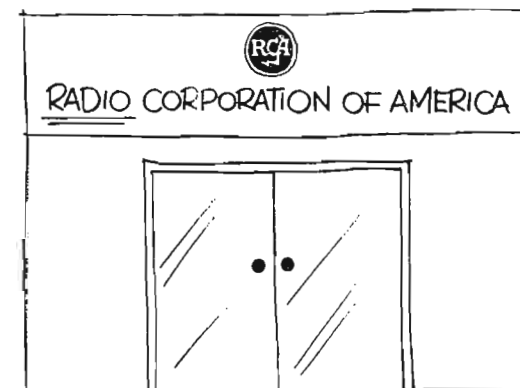
**BROADCAST NEWS***published by***RADIO CORPORATION OF AMERICA**  
BROADCAST & COMMUNICATIONS PRODUCTS DIVISION, CAMDEN, N. J.*issued bi-monthly***PRICE** *in U.S.A. - - - - - \$6.00 for 6 issues*  
*outside U.S.A. - - - \$7.00 for 6 issues***C O N T E N T S**

	Page
Planning AM/FM Radio Stations . . . . .	4
WMJR Brings FM Stereo to Ft. Lauderdale . . . . .	15
WHPC — Compact Kilowatter . . . . .	20
Phillips Academy FM Station . . . . .	22
New Circularly Polarized FM Antenna . . . . .	31
S/N Measurements in Audio Tape Recorders . . . . .	34
Automatic Audio Tape Programmer . . . . .	38
Super Power FM Transmitter . . . . .	44
Giant Step to Miniature Microphones . . . . .	50

**THIS ISSUE** is devoted entirely to radio. We did it on purpose — to emphasize the fact that we are still in the AM/FM equipment business — and very active in it, too, thank you.

*As We Were  
Saying*

There didn't seem to be any other way to make the point. Despite the overwhelming interest in television (among our readers as well as ourselves) we have continued to run a goodly number of articles on AM and FM equipment, and stations. But these tended to be lost (or anyway overlooked) in the TV flood. And some of our radio station readers have accused us of going all-TV — or, at least, of neglecting



them. We hope this issue will convince them otherwise. (*Radio is still our first name.*)

Will this all-radio set a precedent? We don't know. Maybe depends on you. Would you sooner have

one or two all-radio issues a year — or have some radio in every issue? Let us know (or tell your RCA representative). Which reminds us . . .

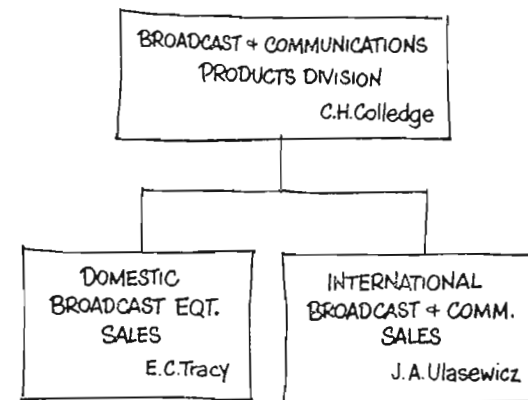
**DO YOU TALK** to your RCA Representative when planning a new installation? You should. He's up-to-date on all the new trends in station design. He can tell you what the industry is doing equipment-wise. He can help you avoid the pitfalls in new station planning.

If you want RCA engineering—for system design, or custom building—he knows how to arrange it. He'll make up any kind of proposal you want, from the simplest to the most elaborate—and revise, revise, revise until it exactly fits your needs. There is no obligation. And even if you don't decide to buy RCA, you will still have gained much in useful knowledge.

Most of RCA's broadcast representatives are graduate engineers and all have had years of experience either in station operations or in RCA engineering. The policy of using top-calibre salesmen, and the principle of "selling by serving," were established forty years ago and have been followed right down to the present. Moreover, the top echelons of RCA's Broadcast Division are almost entirely manned by ex-RCA-salesmen or by men drawn from RCA's broadcast engineering operations. The result is an esprit de corps and a dedication to the broadcast business which is unique in the industry. The RCA representatives who today carry on this tradition in the field are listed on the inside front cover of this issue. They are anxious to prove their helpfulness—and it's to your advantage to use them. How can you lose?

**RCA INTERNATIONAL SALES** offices (and the managers in charge of them) are listed in the box below. We note this to emphasize a point. As of the first of this year the group of salesmen who have been selling our broadcast and communications equipment around the world were transferred to our Division (from the RCA

International Division). Mr. J. A. "Joe" Ulasewicz, who is the manager of this International sales group, will report to the Division Manager, Mr. C. H. Colledge, just as does Mr. E. C. "Ed" Tracy, the manager of our Domestic sales group



(see diagram above). The Broadcast and Communications Products Division thus becomes directly responsible for the sale of RCA broadcast and communications equipment everywhere in the world (except in Canada, where sales continue to be handled by RCA Victor Company, Ltd., Montreal). With this closer tie we hope to be able to provide our international customers with the same quality of service we have always given our domestic customers.

During the past year our international sales force has been enlarged and upgraded. It is planned to continue this program with the goal of making this group the equal (in experience and ability) of our domestic sales force. Equally important we plan to give our international salesmen the same backup we give our domestic salesmen.

**OUR AIM** is to build for our worldwide operation the same image we enjoy in the domestic market. What is this "RCA image"? One of our sales managers defined it as made up of four ideas our customers have of us. These are, according to him, (1) better equipment, (2) an engineering company, (3) no sharpies or con men, (4) RCA people are great guys. That's a pretty miscellaneous definition — but we'll buy it — and we think most of our customers will.

<b>RCA BROADCAST &amp; COMMUNICATIONS PRODUCTS SALES OFFICES — OUTSIDE THE U.S.A.</b>	
RCA Victor Mexicana, S.A., de C.V. Avenida Cuitlahuac 2519 Mexico, D.F. L. F. Guaragna, Sales Manager	Office of the Far East Representative RCA International Division 415 Prince's Building Chater Road, Hong Kong L. L. Cunane, Sales Manager
RCA International Marketing S.A. 118 Rue du Rhone Geneva, Switzerland C. P. Perez, Sales Manager	RCA International Ltd. Calle Paroissien 3960 Buenos Aires, Argentina H. T. Magno, Sales Manager
RCA Victor Company Ltd. 1001 Lenoir Street Montreal, Quebec, Canada W. Holroyd, Sales Manager	

**WALLY WATTS** is back in our part of the business. In a first-of-the-year realignment of RCA's management organization, he assumed executive responsibility for RCA Defense Electronic Products, RCA Broadcast and Communications Products Division and RCA Graphic Systems Division. We're very happy to have him back — and we know his hundreds of friends in the broadcast industry will be, too.

Mr. Watts joined RCA in 1945, as general sales manager of the old Engineering Products Division (which included Defense and Industrial, as well as, Broadcast and Communications Products). He was elected Vice President in Charge of the Division in 1946, and guided our efforts during the tumultuous post-war years that saw the big boom in AM, the rebirth of FM, the start of TV, the freeze, the unfreeze, non-electronic color, NTSC and UHF.

Many of our readers will remember Wally Watts as the genial host of countless NAB's, seminars and "reports to industry." Others will remember him as the longtime and still active ham operator (1912 call WW, present call W4V1). Still others (and they especially) as the man who advised them to get on the air with TV in the days before the freeze.

Mr. Watts has been connected with radio, in one form or another, practically all his life. He built his first ham rig in 1912, when he was only ten years old. A few years later he teamed with E. C. Page in operating amateur station 9BP. This boyhood friendship led to the building of the first WBBM transmitter in the basement of the Watts home. In 1923, he joined Montgomery



**AUGUST 1948.** Wally Watts points out features of RCA's "Basic Buy" to consultants attending special television seminar in Camden. At the time Mr. Watts was Vice President in Charge of the Engineering Products Division (which included Defense and Industrial, as well as, Broadcast and Communications Products).



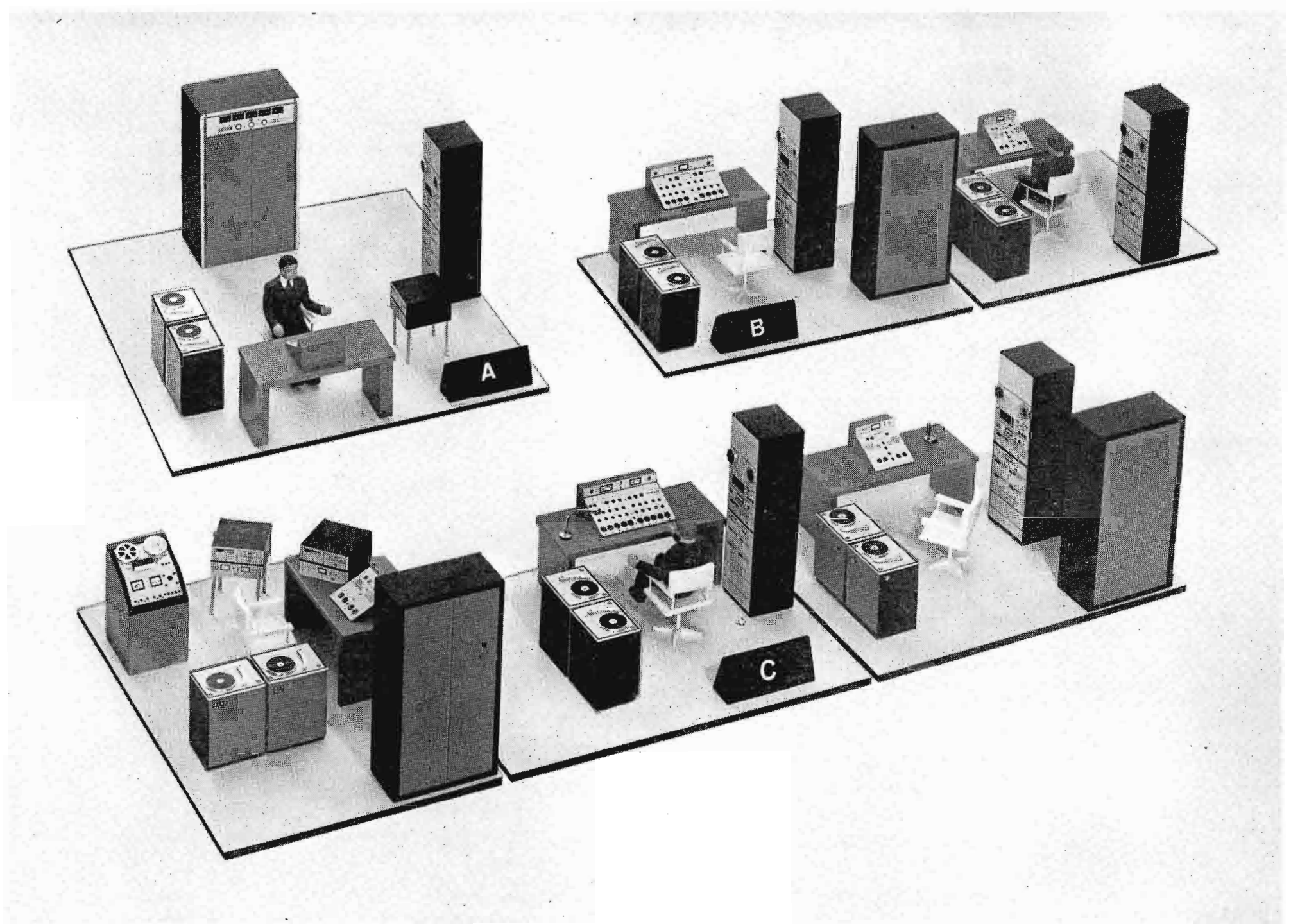
**W. W. "WALLY" WATTS**, RCA Group Executive Vice President, who on January 1 assumed direction of RCA Defense Electronic Products, RCA Broadcast and Communications Products Division and RCA Graphic Systems Division. His new assignment is part of a realignment in RCA's management organization announced in early December by Robert W. Sarnoff, President of RCA.

Ward as a technical writer in the radio department. During the following 13 years he moved up to mail order sales manager for radio equipment and later for all major appliances. In 1936, he moved to Zenith as vice president in charge of the Wincharger Division.

During the war he served as a Colonel and Commanding Officer of the Signal Corps Distribution Agency, and as a Signal Corps Procurement Director.

At the end of the war Mr. Watts joined RCA and, as noted above, served from 1946 until 1953, as Vice President in Charge of the Engineering Products Division. In 1954, he was elected Executive Vice President, Technical Products, in 1955, he was made Executive Vice President, Electronic Products and, in 1958, Group Executive Vice President. In January 1960, a management realignment made him Group Executive Vice President responsible for Consumer Products, Electronic Components and Devices, and Distributor and Commercial Relations. Later that year he was elected a member of the RCA Board of Directors.

The seven years that Mr. Watts headed RCA's Consumer Products activities saw color television finally come of age and sales of RCA's home instruments increase several times over. In returning to the areas of broadcast and defense Mr. Watts comes back to activities which also have grown rapidly. It requires no stretch of the imagination to predict that his lifelong acquaintance with these technical businesses will contribute measurably to their further and continued growth. His assignment to this responsibility indicates that RCA intends that they should.



# PLANNING AM/FM RADIO STATIONS

## PART ONE: THREE BASIC FLOOR PLANS

*Editor's Note: The purpose of this new series is to review for the station planner basic considerations in the selection, layout and installation of radio equipment facilities. The floor plan layouts presented in these articles are typical, but they are not intended for construction use. More complete information on equipment groupings, space requirements and performance specifications may be obtained from a broadcast consultant or RCA Broadcast Representative.*

This is the first in a series of articles on the planning and equipping of AM and FM radio stations. This first part discusses planning of studio facilities and presents a set of floor plans that are typical for three different size stations. Parts two and three in the series cover the layout and construction of the transmitter plant, tower and antenna system, and the selection and installation of equipment.

### Consultant Service

It is usually advisable for those planning a radio station to obtain the serv-

ices of broadcast consulting engineers and attorneys who specialize in preparing application data for FCC station licensing. The application for a construction permit establishes the owner's legal and financial qualifications. It also provides a "blueprint" of the proposed operation so that the FCC can study the owner's program plans, equipment selection, choice of transmitting site, operating frequency, and power, prior to issuing a construction permit.

To further meet the requirements of the c-p application, three major technical

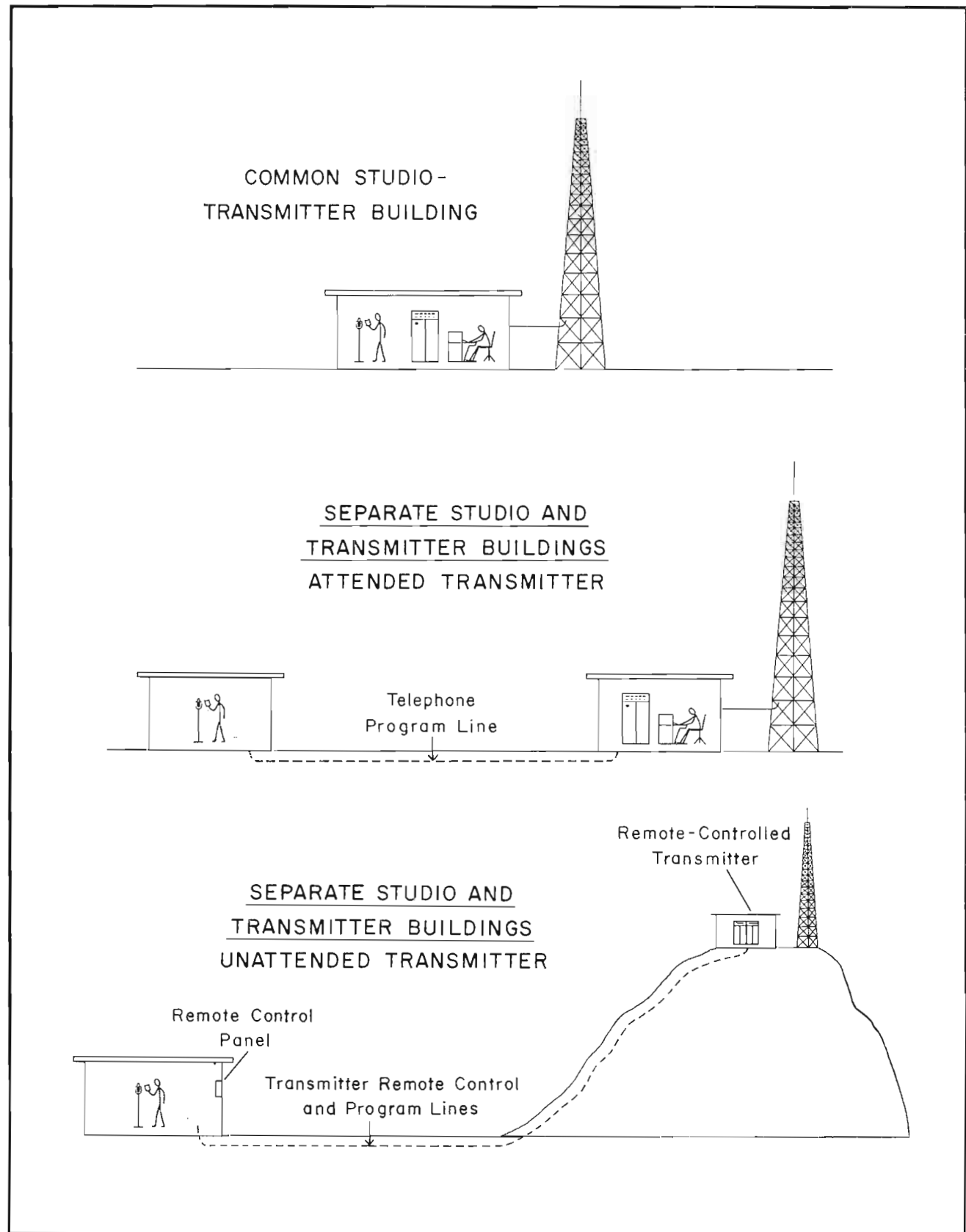


FIG. 1. Three variations in layout of studio and transmitter facilities.

factors must be considered. These are: (1) selection of antenna tower location and height. (2) determination of transmitter power and frequency, and (3) selection of programming facilities. The antenna site and elevation as well as transmitter power and frequency are determined with the help of the consultant after considering the market area to be served, the terrain, and the proximity of existing stations.

The type and volume of programming determines equipment facilities and to some extent, studio space, and station lay-

out. Equipment facilities can be determined with the help of the consultant and RCA broadcast sales representatives who are experienced in system design.

#### Equipment Planning

Equipment facilities should be selected carefully for their support of programming and market coverage. The best approach is through a systems layout plan incorporating the required programming and transmitting facilities. RCA proposals show equipment groupings for studio and transmitter systems, enabling the planner to relate facilities to his operation and

thus make appropriate cost decisions as required by FCC.

#### Choosing Studio and Transmitter Sites

Radio stations, AM or FM, consist basically of a studio facility and a transmitting plant. The studio facility includes the equipment needed for program origination, and the transmitting plant comprises the station transmitter and antenna system. Studio and transmitting facilities may be under one roof, or installed in different buildings separated by some distance and interconnected by telephone lines. The transmitter and antenna tower

system, however, must be at the same location and in close proximity to each other.

The transmitting site is of first interest to the FCC since it must be selected with consideration to existing stations that might be in the area.

It is generally considered most economical to combine studio and transmitter equipment in one building. This minimizes the investment for land and equipment, lowers costs for heating and air conditioning, and may reduce the operating staff.

The combined site must meet the requirements of a good transmitter location, offering sufficient room for towers and achieving the desired signal coverage. From the studio standpoint, it should be conveniently accessible to station personnel. Separate sites, however, are sometimes necessary to avoid compromise in technical performance and operating efficiency. For example, it may be advisable to take advantage of a high mountain peak for the transmitting location and acquire a studio site that is closer to the city and easily accessible. A modern trend is to locate the studio plant in or near centers of business activity thus placing the plant on display to passers by. In some areas, zoning regulations prohibit erecting towers on otherwise ideal studio-transmitter locations.

When combined studio-transmitter facilities are not practical, it may be worthwhile to consider the advantages of operating the transmitter by remote control. The building containing the remotely controlled transmitter can be a very mini-

mum in size, allowing only space for the equipment, a small work area, lavatory and a room heating unit. Remote control of transmitters is discussed in Part Two of this series.

#### Remote Studio Facilities

Thought should be given to facilities for picking up remotes. Portable or mobile systems are useful for on-the-spot coverage of happenings in and around the city or community. It is common practice for stations to install provisions for quickly plugging in a remote amplifier such as the RCA BN-16B at eating places where prominent social, business or political personalities might be interviewed, or also at places of business, sports arenas, or in entertainment centers from where special variety or music programs could be broadcast. The remote amplifier provides mixing and amplification of signals to a level suitable for transmission over a telephone line to the studio.

#### Studio and Control Room Consideration

The AM or FM studio is receiving less consideration in present day operations because fewer live programs are being originated. However, sufficient thought should be given to studio planning, looking toward ultimate requirements.

Control rooms are alike in many respects, differing mostly in the number and arrangement of microphones, turntables, tape recorders and other program sources, and consequently in the size and complexity of facilities such as the control console. Many stations locate the control console and an announce microphone on a table in front of the studio viewing win-

dow. They place the turntables on one or both sides of the operator's position at the console, and locate tape machines within easy reach on the table or in a tape console beside the operator.

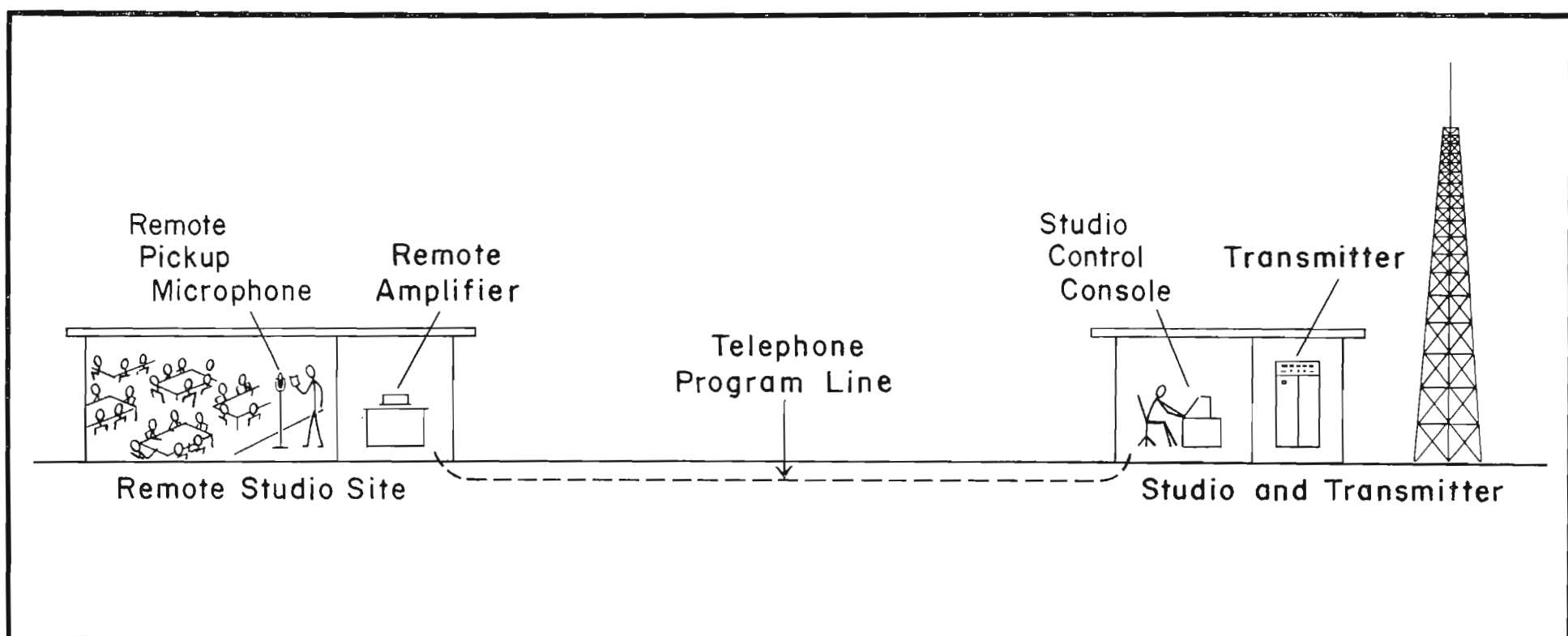
Provisions should be made during construction for a house monitoring system that will carry audio to offices, clients' rooms, the lobby area and other locations throughout the building. Beside program material, it can provide a convenient closed circuit system for auditions and special monitoring.

#### Typical Floor Plans

Presented on following pages are floor plans "A", "B" and "C" for three stations differing in size, facilities and layout. Plans "A" and "B" occupy 1,200 and 2,900 square feet, respectively and can be used for either AM or FM. Plan "C," covering 3,500 square feet is for a combined AM-FM facility.

These floor plans do not necessarily represent existing stations, but they show typical layouts of studio equipment for efficient operation of the stations. Accompanying each floor plan is a system diagram and a list of the major equipment items used in the layout. Facilities such as heating and air conditioning equipment are not shown but should be selected in accordance with individual requirements. As indicated in the plans, provisions can be made to house the transmitter in the same building with the studio equipment if desired. For layouts of complete transmitting equipment, the reader is referred to Part Two in this series on station planning.

FIG. 2. Pickup and control equipment installed in public meeting places to provide additional program sources.





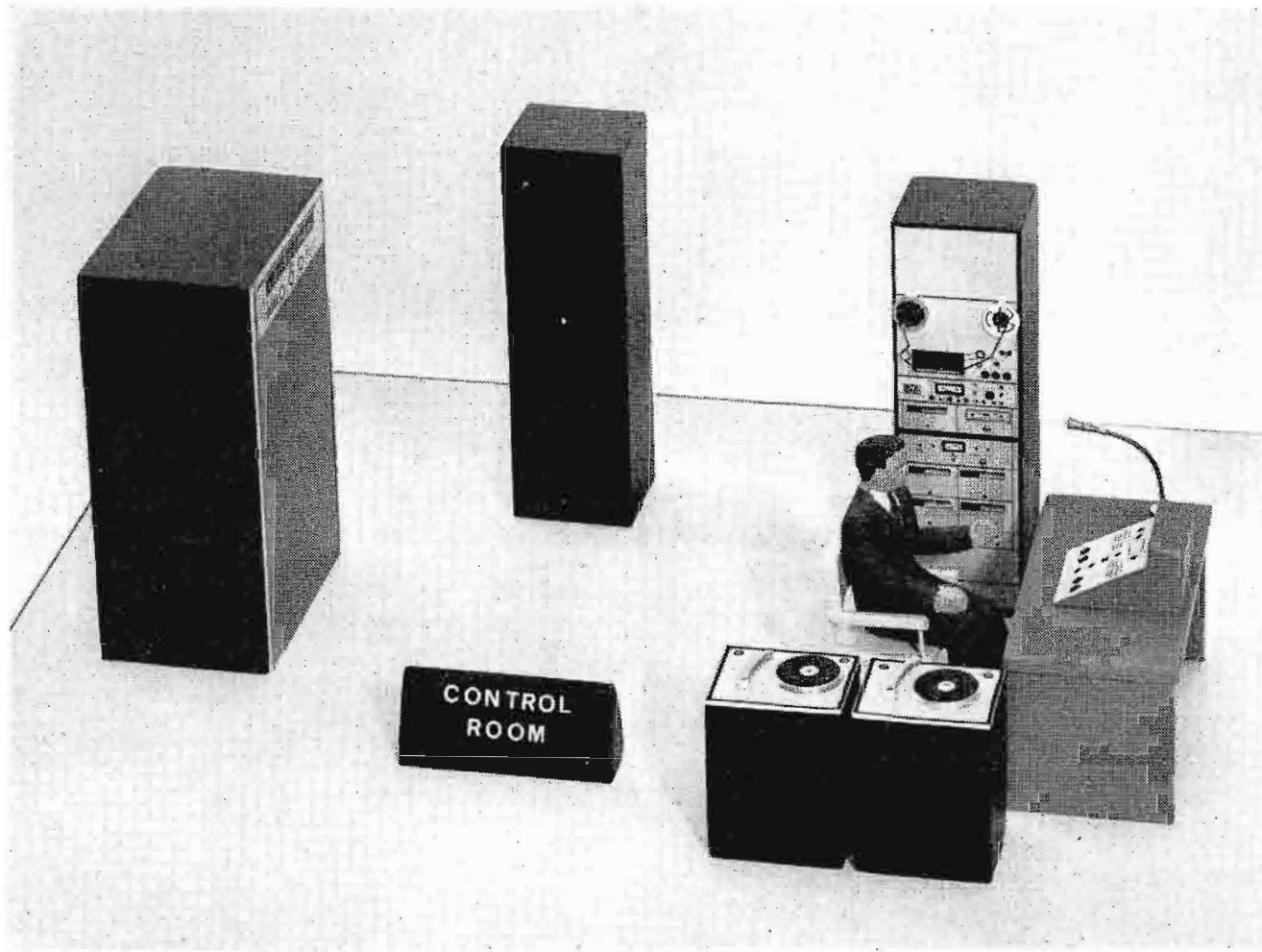


FIG. 3. Plan "A" control room with transmitter, cartridge and reel tape recorders, audio console and transcription turntables.



FIG. 4. Alternative locations for cartridge and reel tape facilities.

## PLAN "A" STATION

### A Minimum Investment Facility

Plan "A" layout is designed for the AM or FM station that proposes to start with a minimum investment. It includes the transmitter plus the necessary technical equipment to handle a complete program schedule, such as (1) announcements, (2) disc and tape recordings, (3) network, (4) remotes, and (5) live shows including news, interviews, small orchestras.

Simplicity is the keynote for Plan "A". It occupies a small space, employs a minimum of equipment and is arranged to require minimum personnel. A single operator-announcer works directly from the control room, with turntables, tape

recorder, control console and overhead record rack (not shown) all within easy reach.

Access to the control room or studio is via a sound lock common to the office area. A soundproof wall partitions off the transmitter to minimize noise in the control room.

The equipment list and system diagram show the main equipment items and how they are interconnected. The modulation monitor, frequency monitor and amplifiers are rack mounted units. A few other accessory items required by the system do not appear in this diagram.

MAJOR EQUIPMENT	
QUANTITY	ITEM
4	Microphones
2	Two-Speed Turntables
1	Professional Tape Recorder
1	Audio Console
2	Multi-Cartridge Tape Playback Units
1	Cartridge Tape Record/Playback Unit
2	Cue Amplifiers
1	AGC/Limiter Amplifier
1	Cabinet Rack
1	Transmitter
1	Antenna System
1	Modulation Monitor
1	Frequency Monitor

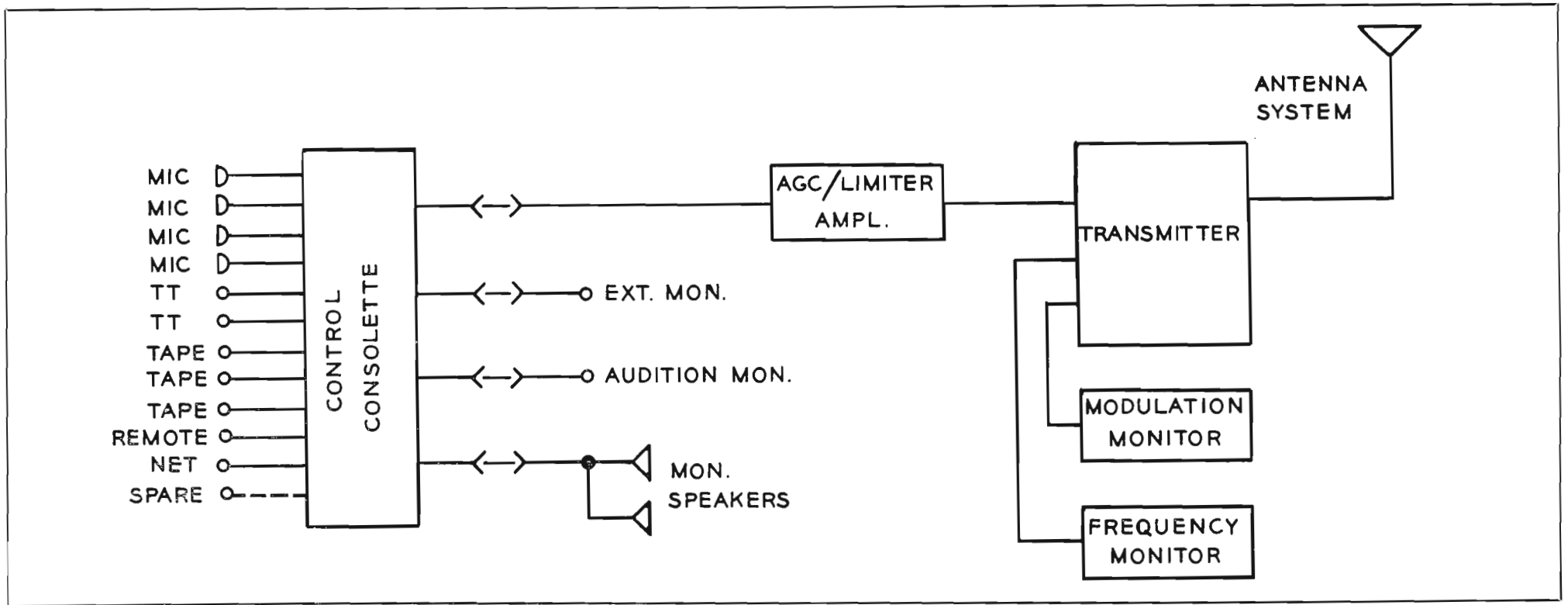


FIG. 5. Simplified diagram of system showing patch facilities at output of console.

PLAN "A"  
STATION  
Continued

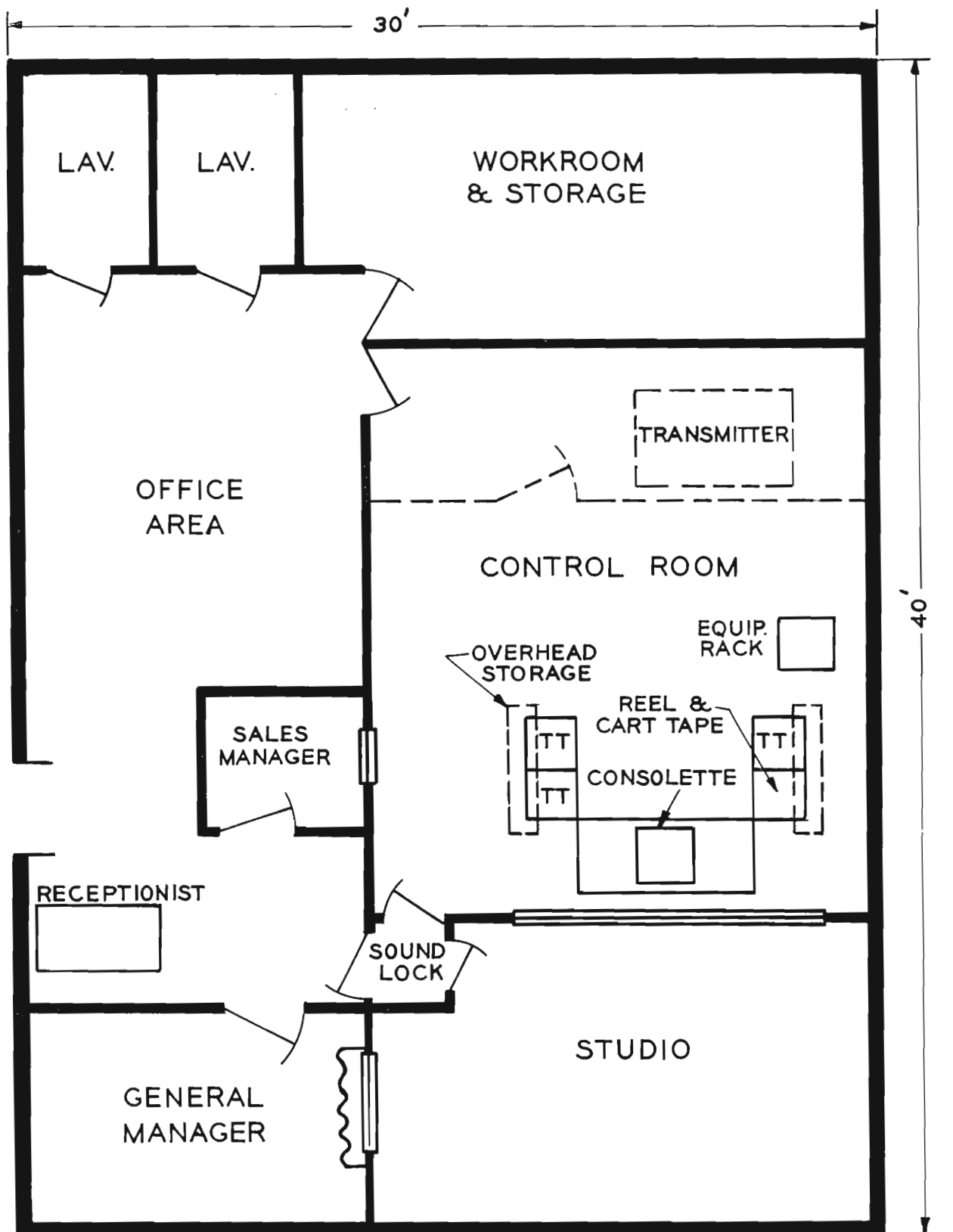


FIG. 6. Typical layout of the Plan "A" station. Dotted lines indicate optional location of transmitter and soundproof wall.

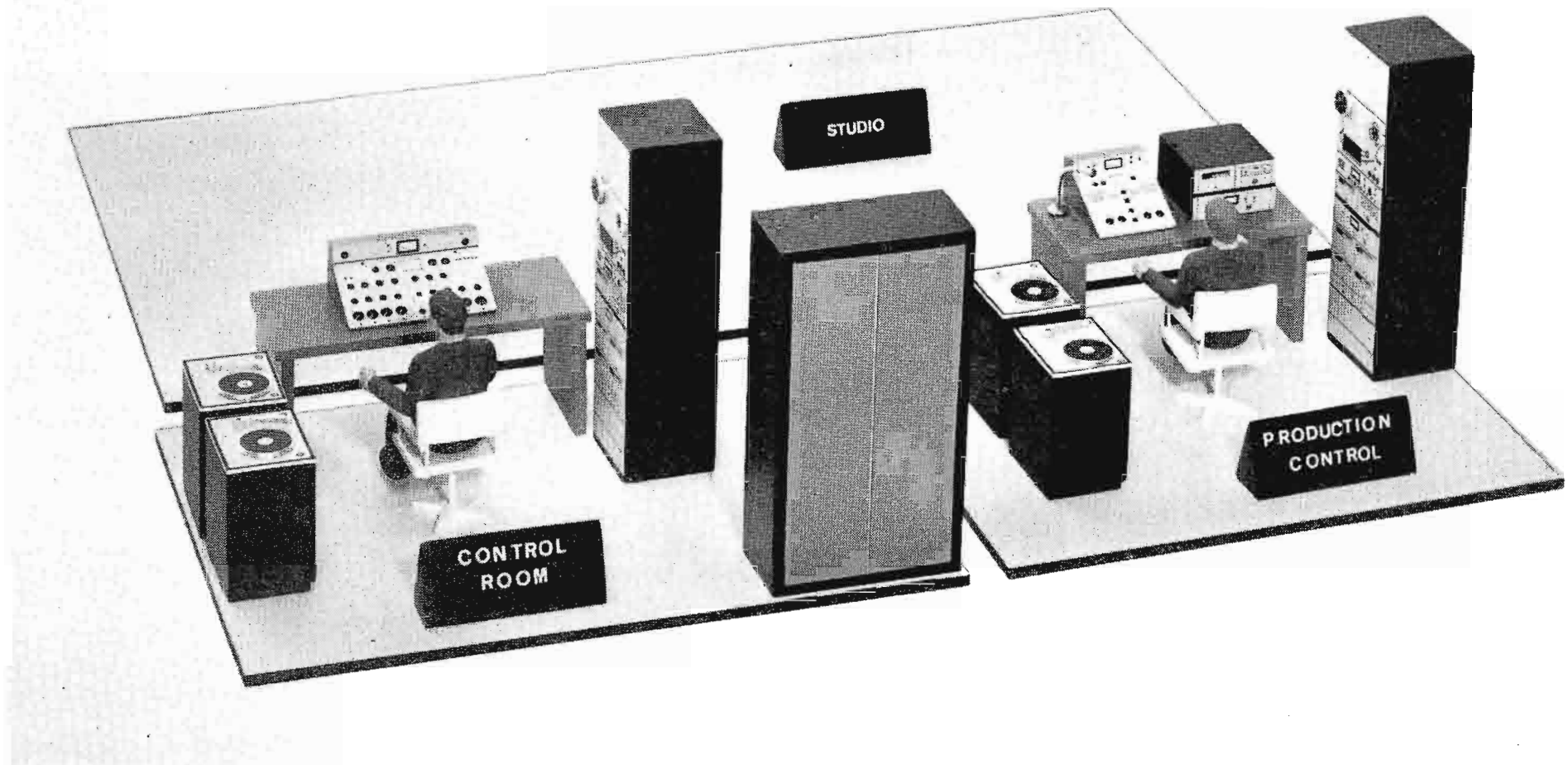


FIG. 7. Program and production control equipment of the Plan "B" station.

## PLAN "B" STATION

### Medium Size Community Type Station With Expanded Plan "A" Program Facilities

Plan "B" greatly expands the program facilities of Plan "A," offering more than twice the space and in addition featuring a production control room, announce booth and record library. It could be a very desirable arrangement for the community type AM or FM radio station.

The 26 by 25 foot studio will sustain a substantially large live show. The production control room is convenient for the production of recorded tapes, news, spots, promos or music interludes for future broadcasts. Since it utilizes a control console, it can also serve as an alternate

operating position to air recorded programs. The record library permits the auditioning of records, building of shows, cataloging, filing and other activities to be carried on away from the program operations area. The floor plan shows an optional extension to the building that could either house the transmitter or offer additional storage space.

Stations desiring to eventually equip a layout such as this, but wishing to start on a smaller budget, might consider eliminating some facilities such as the production control room, but at the same

time retaining the area and using it for other purposes until they are ready to expand facilities.

The equipment list and system diagram show the major equipment complement which includes the two control consoles, tape machines, microphones, amplifiers and transmitter and test equipment units. The modulation monitor, frequency monitor and amplifiers are all rack mounted. There are a few accessories not shown that are required for an operating system.

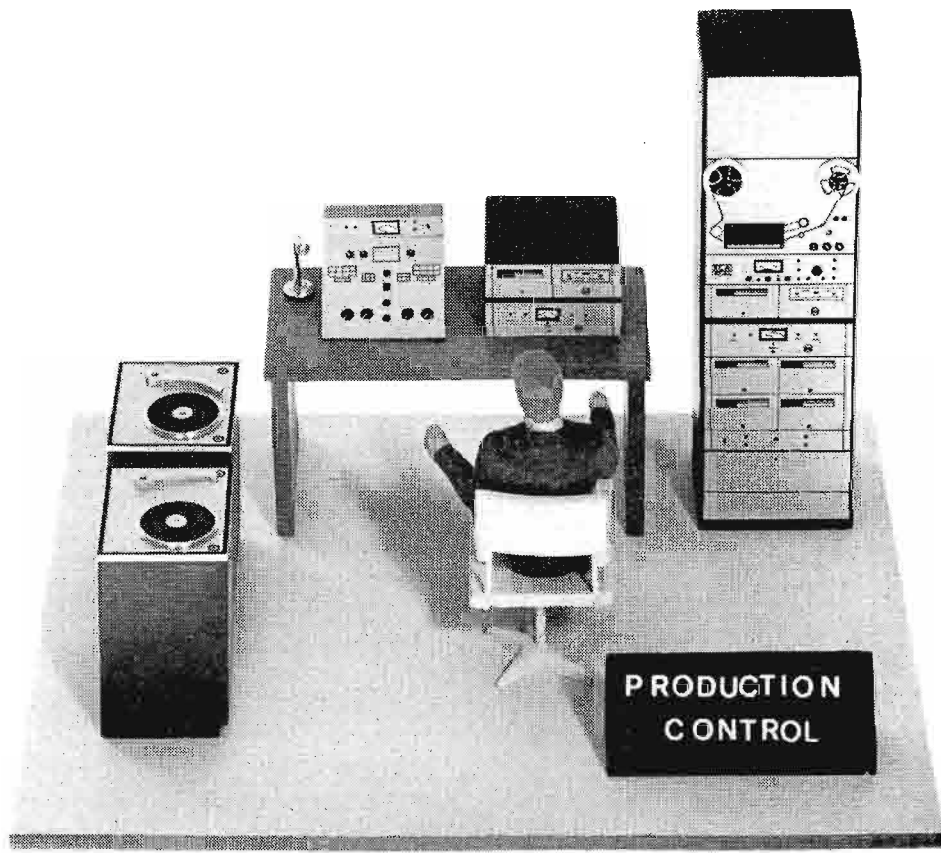
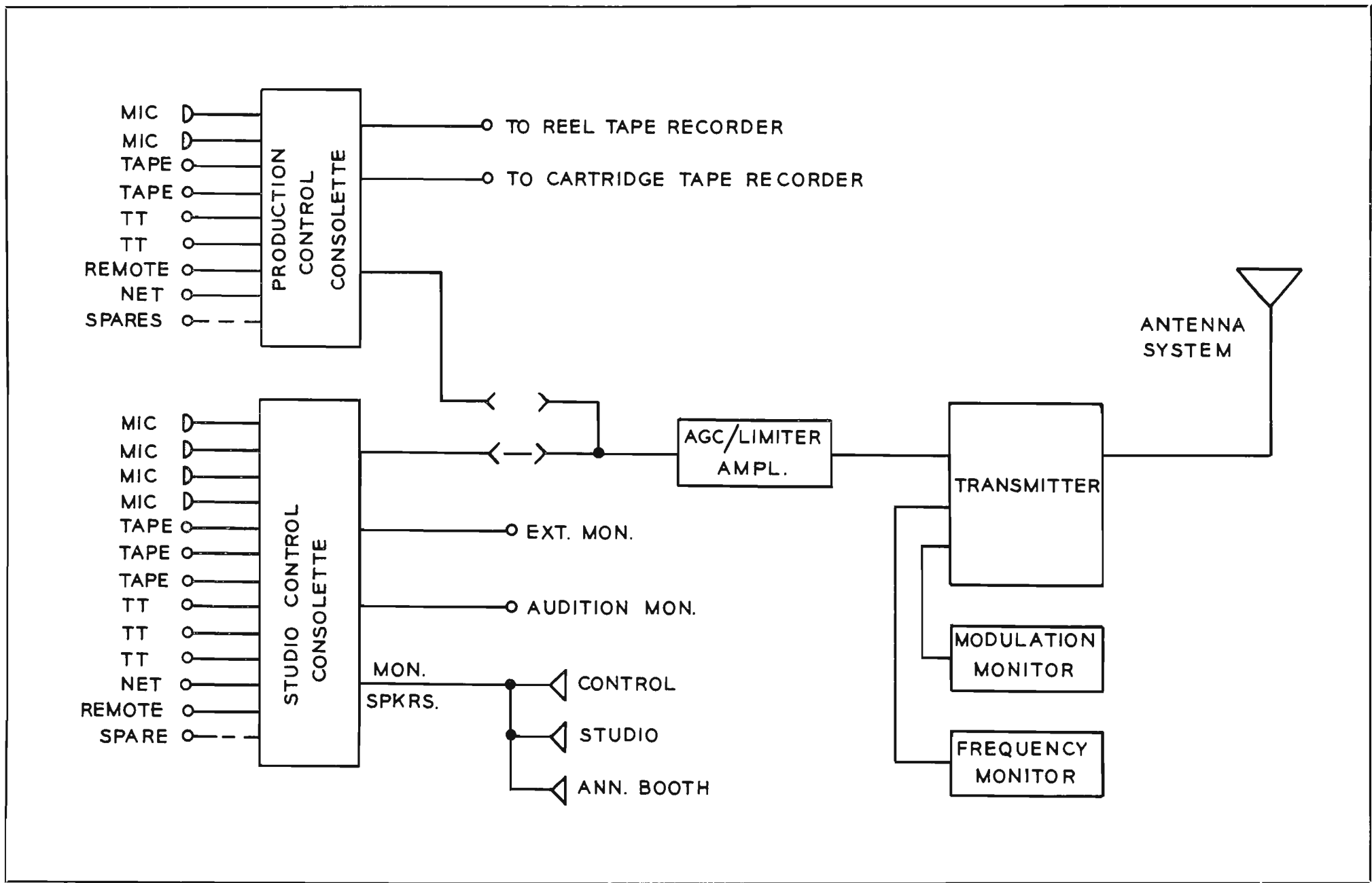


FIG. 8. Production control equipment includes console, cartridge and reel tape machines, microphone and turntables.

MAJOR EQUIPMENT	
QUANTITY	ITEM
6	Microphones
5	Two-Speed Turntables
2	Professional Tape Recorders
2	Audio Consolettes
1	Multi-Cartridge Tape Playback Unit
2	Cartridge Tape Record/Playback Units
1	AGC/Limiter Amplifier
2	Cue Amplifiers
2	Monitor Amplifiers
5	Cabinet Racks
1	Transmitter
1	Antenna System
1	Modulation Monitor
1	Frequency Monitor

FIG. 9. System diagram showing how production control can also be patched into output line.



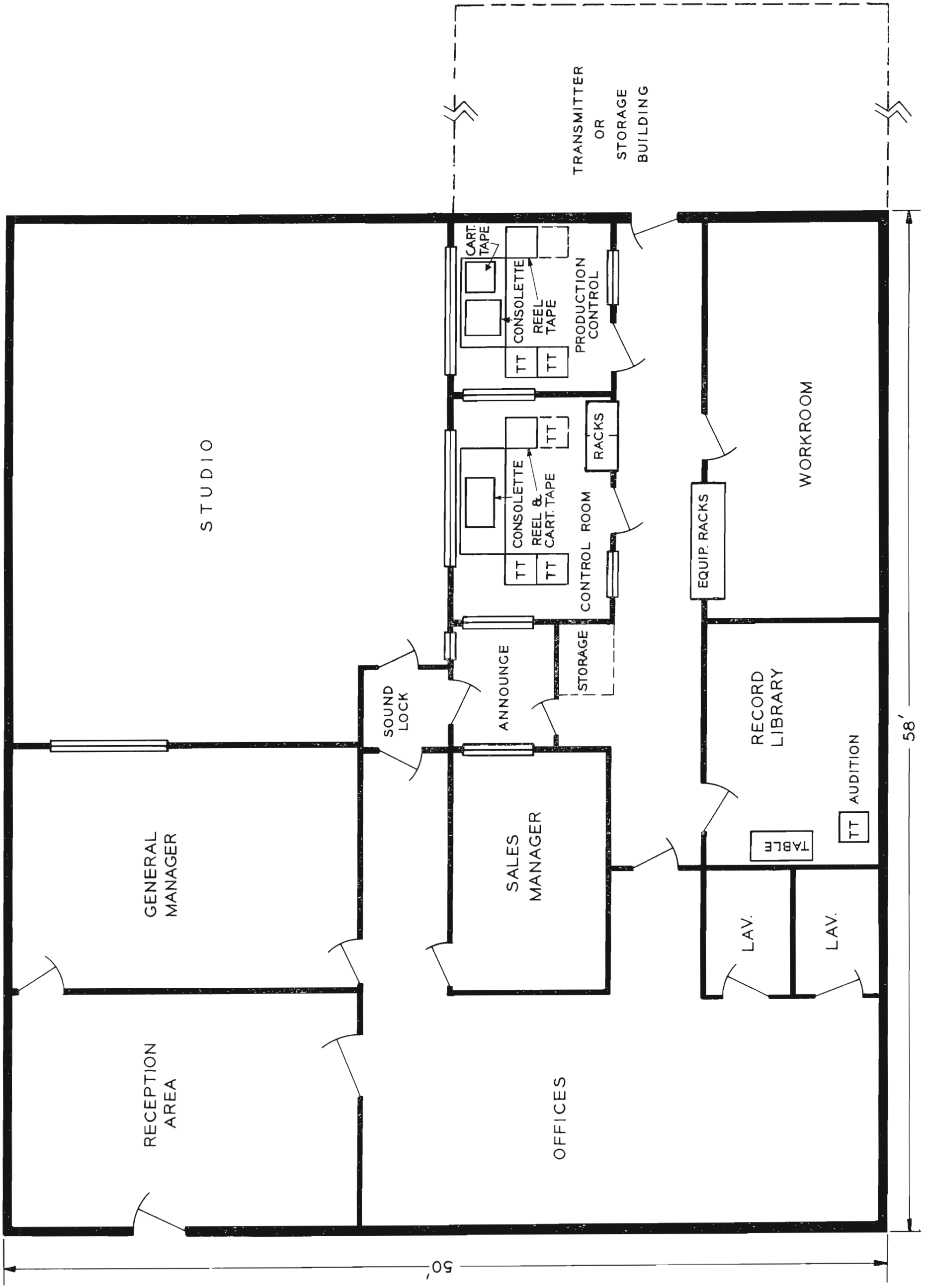


FIG. 10. Floor plan and equipment layout for Plan "B" station.

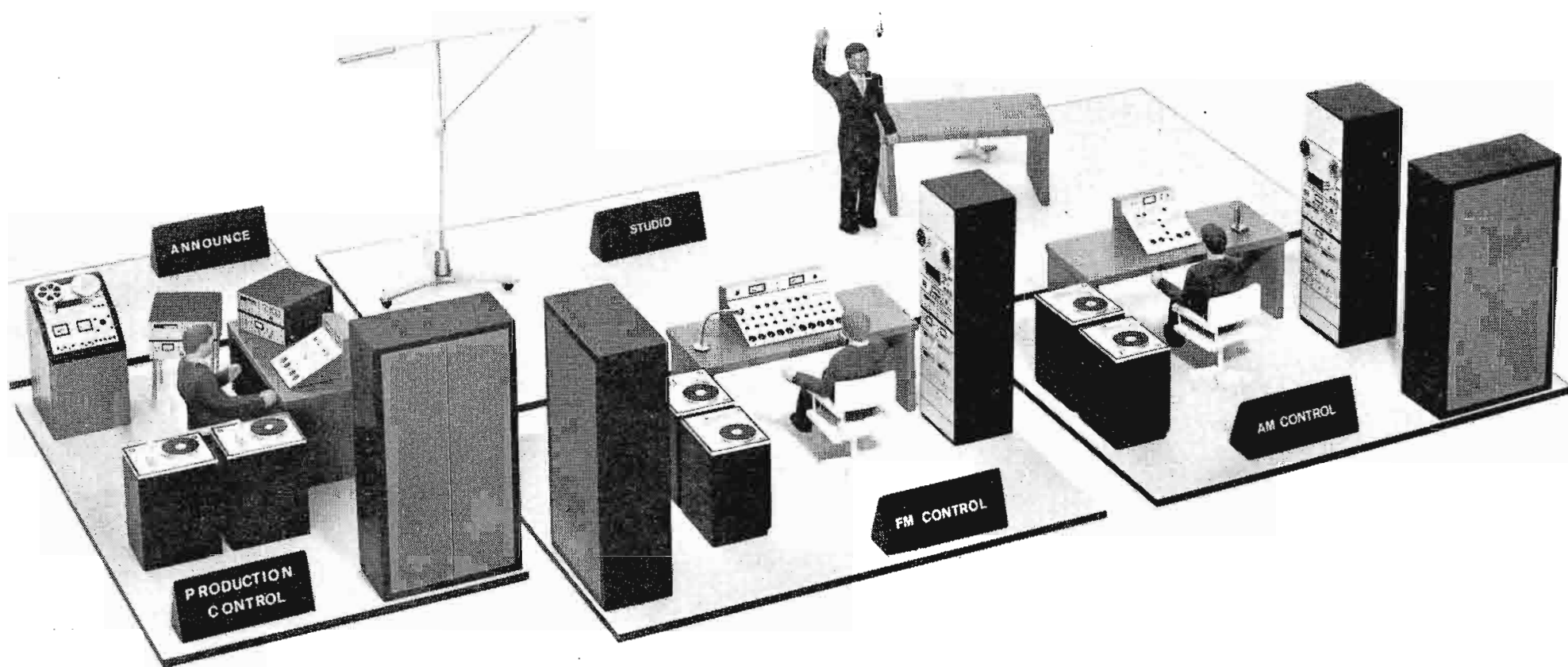


FIG. 11. Models showing control room equipment arrangement in Plan "C" station.

## PLAN "C" STATION

### Separate AM/FM Control Facilities

Plan "C" though similar to Plan "B" offers a combined AM/FM broadcast facility featuring individual AM and FM control rooms and somewhat larger studio, production control room library and workshop areas. Similar console, tape and turntable facilities are used in the AM and FM control rooms, with the FM control room equipped for stereo. While production control is designed primarily for recording, there is space to add a second control console, if desired, and thus expand the operational capabilities of this room. The 25 x 28 foot studio should easily handle choral groups or a full orchestra and permit audience participation programs. Some of the additional space in the workroom is used to house program automation equipment and news machines. As suggested in Plan "B," the building may be extended to house the transmitter or for additional storage space.

Transmitting equipment layouts are described in Part Two of this series of articles.

The equipment list and system diagram show the major units and how they are interconnected. The modulation monitor, frequency monitor and amplifiers are all rack mounted units. The operating system requires some accessory units that are not shown in the diagram.

#### Conclusion

The diagrams of Figs. 12 and 13 on the following pages conclude this Part One article on the planning of studio facilities for AM and FM radio stations. Part Two of the series discusses layout and installation of the transmitting plant, including considerations in the design of the antenna tower system and in remote control practices. Part Three of this series presents guidelines in choosing equipment facilities.

MAJOR EQUIPMENT	
QUANTITY	ITEM
12	Microphones
7	Two-Speed Turntables
3	*Professional Tape Recorders
2	*Dual Channel Audio Consolettes
2	*Audio Consolettes
4	Cartridge Tape Record/Playback Units
2	*Multi-Cartridge Tape Playback Units
3	AGC/Limiter Amplifiers
4	Cue Amplifiers
6	Cabinet Racks
1	AM Transmitter
1	FM Transmitter
1	AM/FM Antenna System
2	Modulation Monitors
2	Frequency Monitors

\* Stereo or monaural types

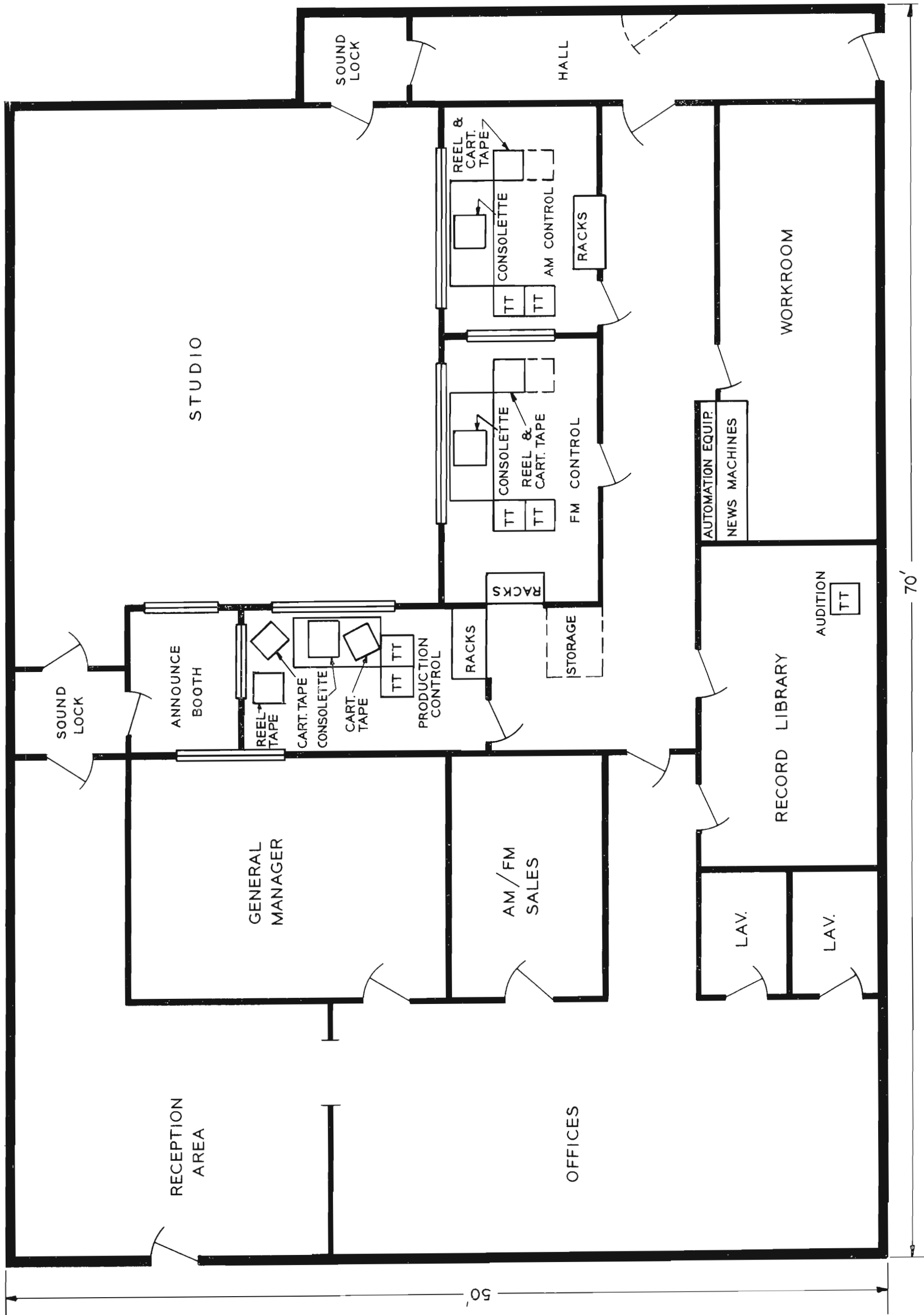


FIG. 12. Typical layout of combined AM/FM equipment facilities of Plan "C" station.

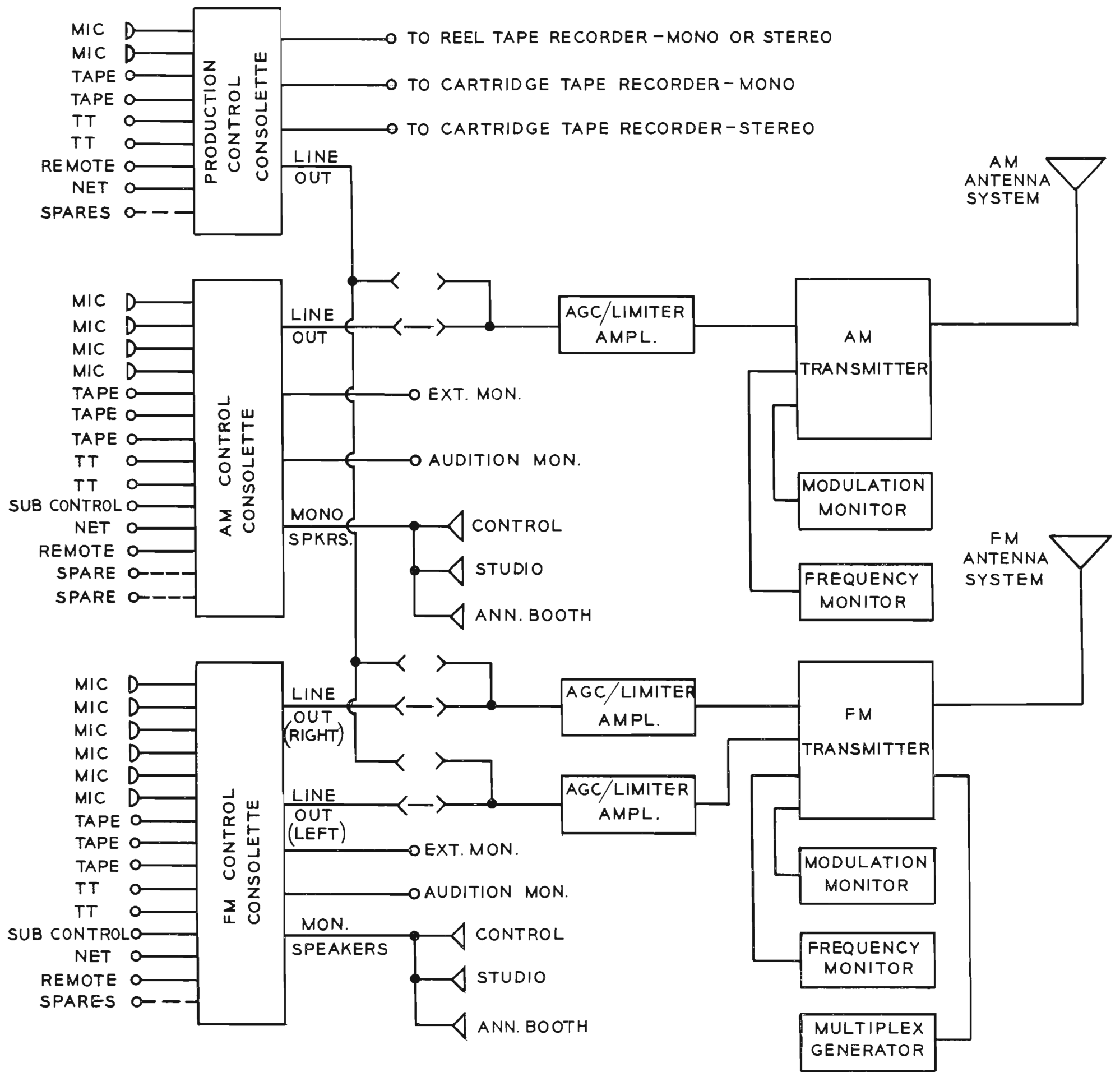


FIG. 13. System diagram of Plan "C" station.



# WMJR BRINGS FM STEREO TO FORT LAUDERDALE AREA

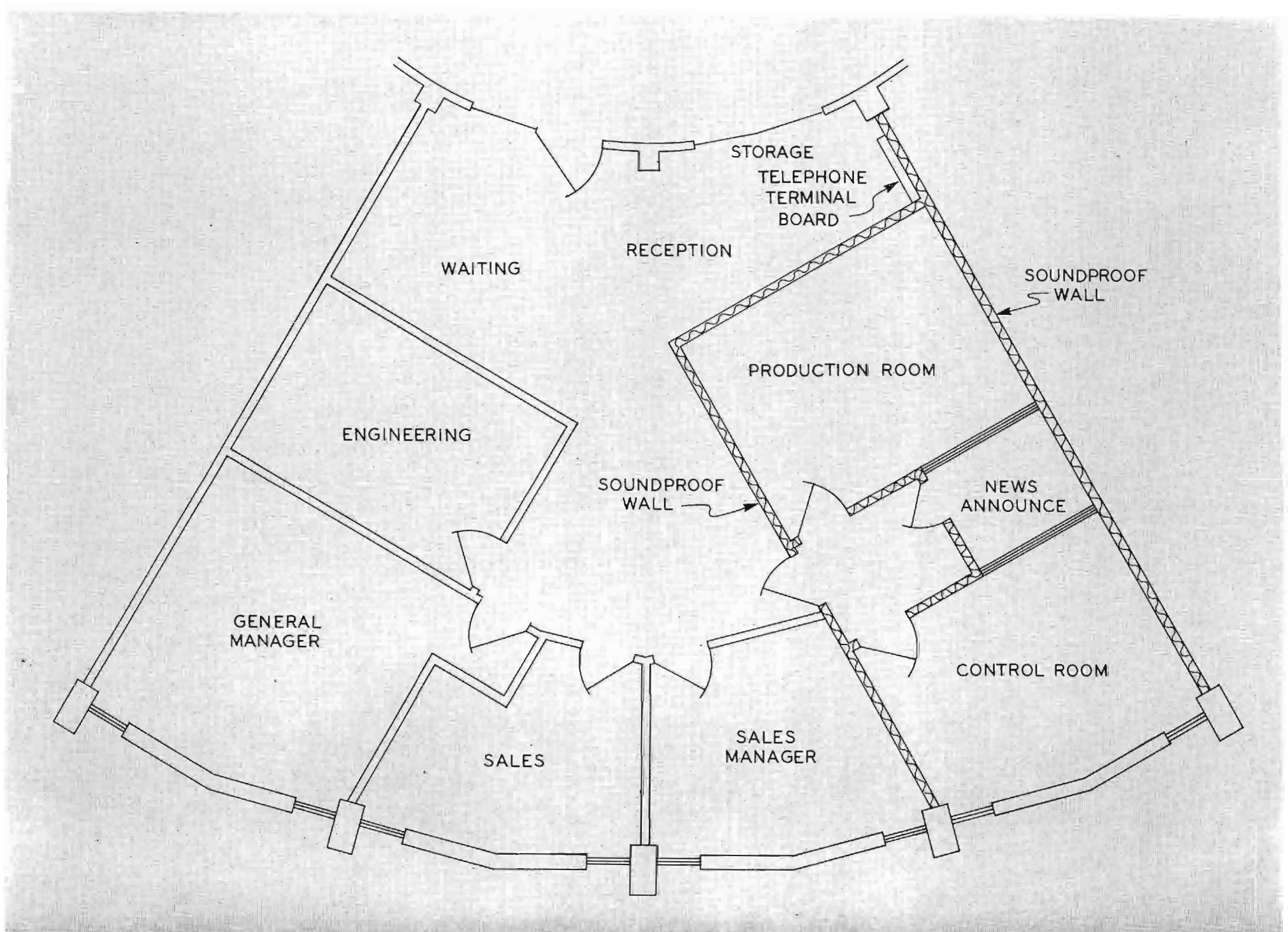
10-KW FM Station Selects Finest FM Equipment and Over Two Year Period Broadcasts Successful Program Format of Good Music, News, Weather and Sports Around the Clock

by RON CRIDER

*Chief Engineer, WMJR*

*Fort Lauderdale, Florida*

**FIG. 1.** Plan arrangement of WMJR-FM facilities on the fifth floor of the circular Kenann Building. Most of the station's programming is first taped in the production room and then broadcast from the control room, although either facility can be used to air programs. A remotely controlled RCA "New Look" 10 kilowatt transmitter is located below the roof of the building under the tower.



With a unique station format and highest quality equipment, WMJR went on air September 1, 1963, in Ft. Lauderdale, Florida, with FM stereo programming. After two years of operation and use of a "listener panel" to guide programming, the station has found widespread acceptance and some one hundred local accounts have been acquired. As a result, plans are afoot to increase power of the transmitter from 10,000 to 20,000 watts, to increase antenna height, and add vertical polarization. The station also has an SCA service under lease to a background music company.

Station WMJR-FM operates on a frequency of 100.7 mc, originally from 7 am to midnight, but for the past 2 years round the clock. The station is owned by Anderson-Brandel, Inc., who also owns resort hotels and other industrial enterprises. An unusual tripartite administration handles the station's activities: Ron Crider, Chief Engineer; Bud Melton, Program Manager; Bob Roberts, General Manager. The staff includes four announcer-producers besides secretary and part-time assistant engineer, and salesmen.

The station is located on the fifth floor of the new Kenann Building, which is a modern circular office building situated in an area of several large shopping centers in North Ft. Lauderdale. Fronting on the main highway in the area, U.S. 1, the station is ideally situated for contacts with, and visits by, local businesses.

The station is designed to operate efficiently in commercial production, traffic, and presentation. One part of the suite in the Kenann Building is devoted to offices, the other side to programming and production. In this latter, there are: Main control room, news announce booth, news department, record library, and production room.

The transmitter is located at the top of the building in a room under the roof. Directly above, atop the building is the tower. A 10 KW Type BTF-10E FM Transmitter is employed with FM stereo equipment. A type BFA-6-Bay antenna is sidemounted on the tower. The signal is well received in the Ft. Lauderdale and surrounding Broward County area.

#### Control Room

Equipment here includes the famous RCA Type BC-7 Stereo Control Console with two Turntables and Cartridge Tape equipment. Rack mounted equipment includes three RT-37 Stereo Cartridge Tape Machines, remote extension meters for BW-73 Multiplex Modulator Monitor, and

the station-built remote control system for the FM transmitter.

From this control room, the greater part of the programming is put on the air. Most of the music is on tape, advertising spots are on cartridge tape, and announcements are made live. Tape is employed for music to achieve stability of programming as well as highest quality sound. Use of tape permits pre-programming to a fixed format rather than a variety of individual formats, which results when records are used. Further, stereo records go bad fast, since FM stereo is very sensitive to even tiny niches and scratches.

Attached to the BC-7 is a special master remote switching panel. This incorporates pushbuttons and indicator lights for start and stop of:

1. Eight reel-to-reel tape machines
2. Six cartridge tape machines
3. Four transcription turntables

The actions are all relay controlled. The panel was designed and built by the station's chief engineer.

#### Delegating Control

The BC-7 in the control room is hooked up with that in Production so that either can be used for the on-air operation. In either room, the other BC-7 may be chosen for main control. However, the Control Room BC-7 is the master and can refuse to permit delegation.

All live announcements are made from the control room. These are done in stereo, using two 77DX microphones. The reason for this is to achieve as much naturalness as a face-to-face experience.

FIG. 2. Control room equipment includes the BC-7 stereo control console, two turntables (not visible) three cartridge tape recorders, two stereo reel-to-reel tape machines, two 77DX microphones for stereo announcements, remote extension meters for the BW-73 FM multiplex monitor and a transmitter remote control system. Gary Hoffman is the announcer shown here.



### News Booth

This is located between the production and the Control Room, and has glass windows looking in both these rooms. Equipment here includes the teletype machines from two wire services. Also facilities for making "off the phone" recordings.

A cartridge tape player is used for stereo spots and announcements. A BN-6 Portable Remote Control is used for news, and a communications receiver for foreign news. (Everything is in stereo except the news.)

Overhead three speakers are wall mounted:

1. Monitor for police radio
2. Monitor for communications receiver
3. Station monitor

Thus, all facilities for producing the news program is available in this office.

### Production Room

The technical equipment here is of the same fine quality as in the master control. Another BC-7 Stereo Audio Control Console is used with a Turntable and two reel-to-reel Audio Tape Recorders. An RT-37 Stereo Cartridge Tape Recorder is employed for make up of all except singing spots. The station staff writes copy for spots.

Cartridges are made up here for repetitive items—announcements, spots, sign-ons, etc. Although designed for production, on air programming can be delegated to this console, and this is done on occasions. All the announcements, spots, and program material produced in this area is on stereo tape equipment. The staff also produces spots with musical backgrounds.

Indicative of the individuality displayed by the station are the custom designed panels built in the control and production rooms. Mounted at the base of the consoles they permit the operators to start and stop turntables and tape equipment directly from the panel without moving away to operate these equipments locally.

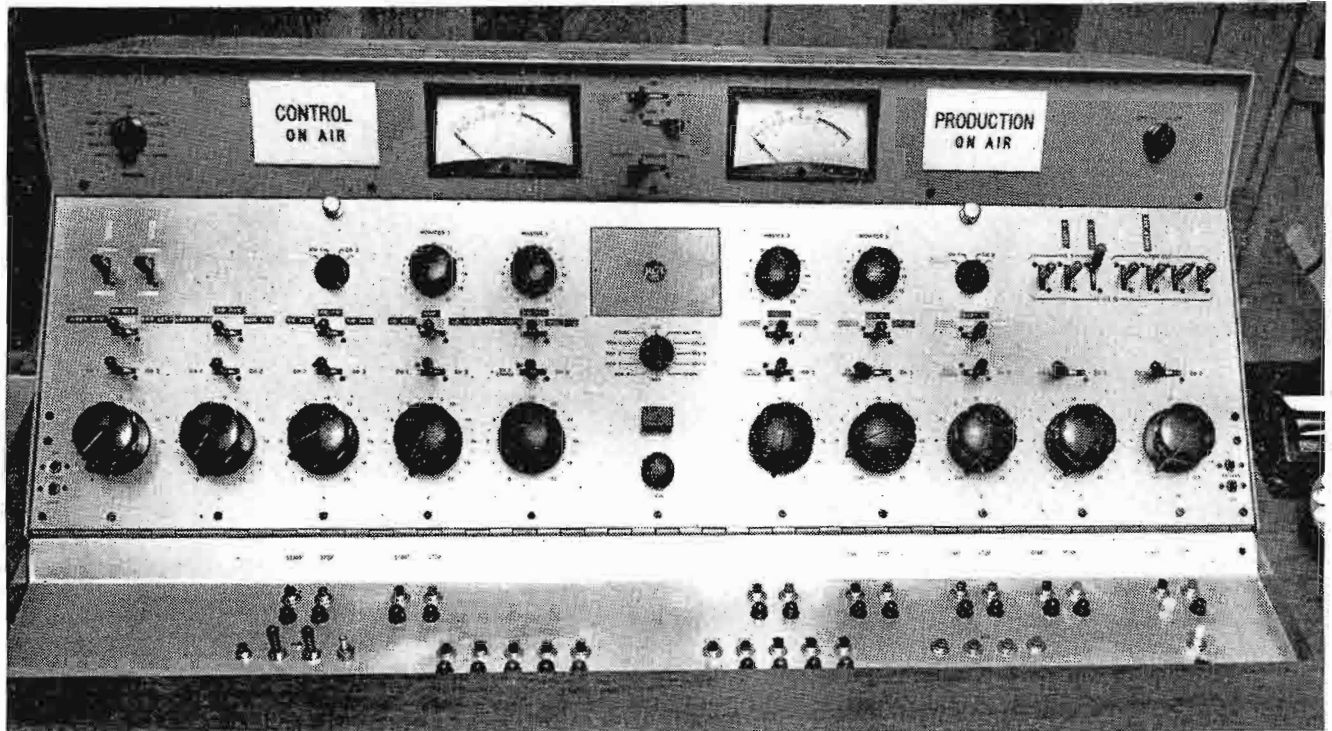


FIG. 3. BC-7 all transistor dual channel consolettes are used in the control room and production rooms. These stereo consolettes are tied together so that either one can be used for on-air operation, with the control room BC-7 connected as the master. All amplifiers in these consolettes are plug in types. The switching panel seen below and attached to each BC-7 is a station-built control facility for remote operation of tape machines and turntables.

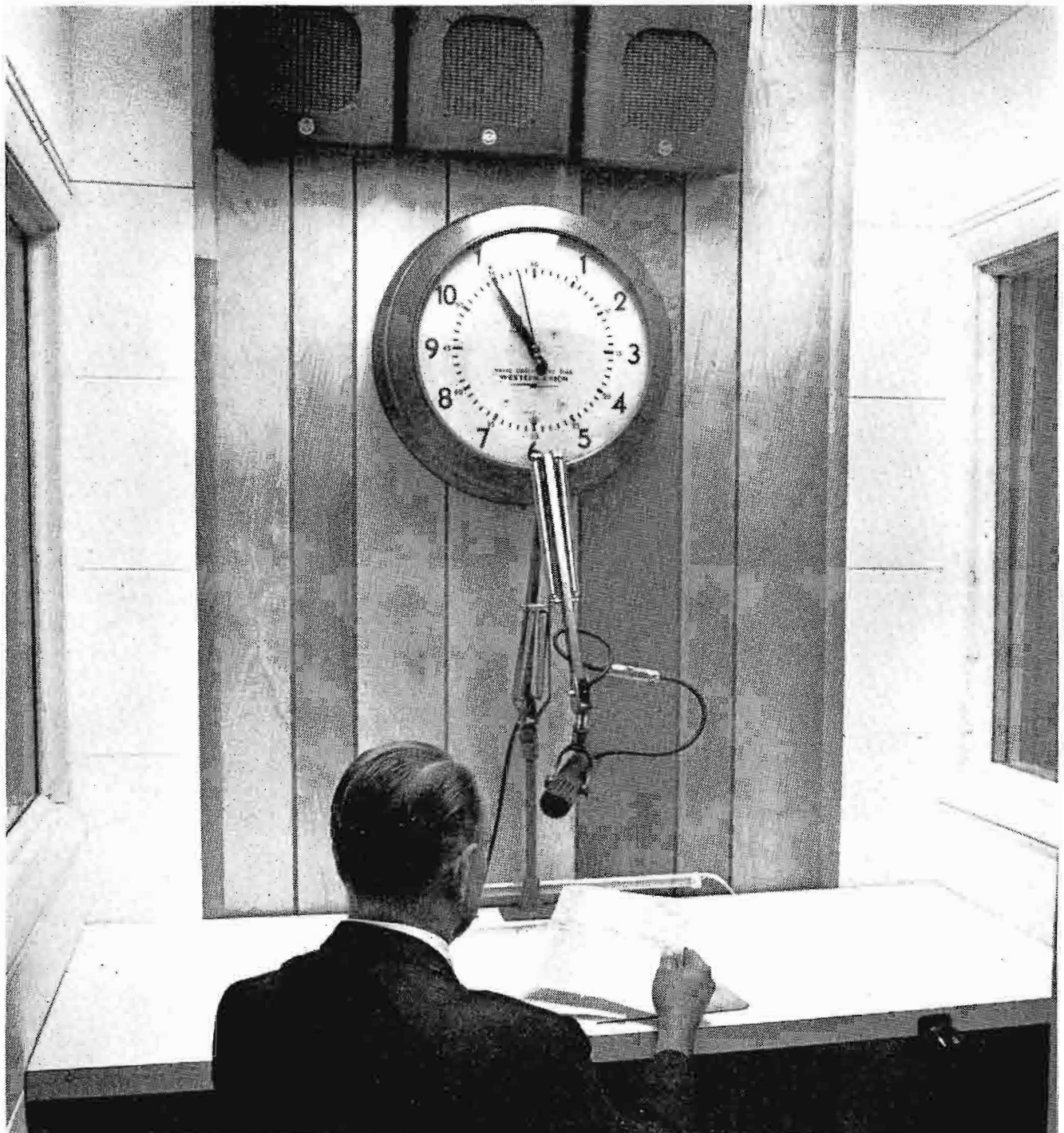


FIG. 4. The news announce room contains speakers for police radio, for a foreign news short wave receiver and a monitor for the station program line. Other equipment includes a BN-6 portable remote control, teletype machines for two wire services and facilities for "off-the-phone" recordings.

### Program Format

The station has found that the "good music" format is a successful formula in South Florida for FM stereo. Semi-classical productions are used during the dinner hour — a type of classical music for people who don't like classical music. This station has coupled the news-weather-sports-format of high class AM stations with the good music format of FM stations to forge a distinctive image for itself in FM Stereo.

A typical program day runs as follows:

Midnight-4 am: Music in the Night

4 am-6 pm: Holiday in Stereo

6 pm-8 pm: Music for Dining

8 pm-Midnight: Music to Midnight

News and weather are programmed every hour on the hour. From 7 am to 10 pm, five minutes is allotted each hour. Headlines and weather continue through the darkness hours from 11 pm to 6 am.

### Built-in Flexibility

Not only has the finest technical apparatus been selected, but the station has also provided two centers of operation that give unusual flexibility, and assurance that any temporary problems in either area can be bypassed. Each control is ready for on-air use—by merely throwing a switch, it takes the on-air circuit.

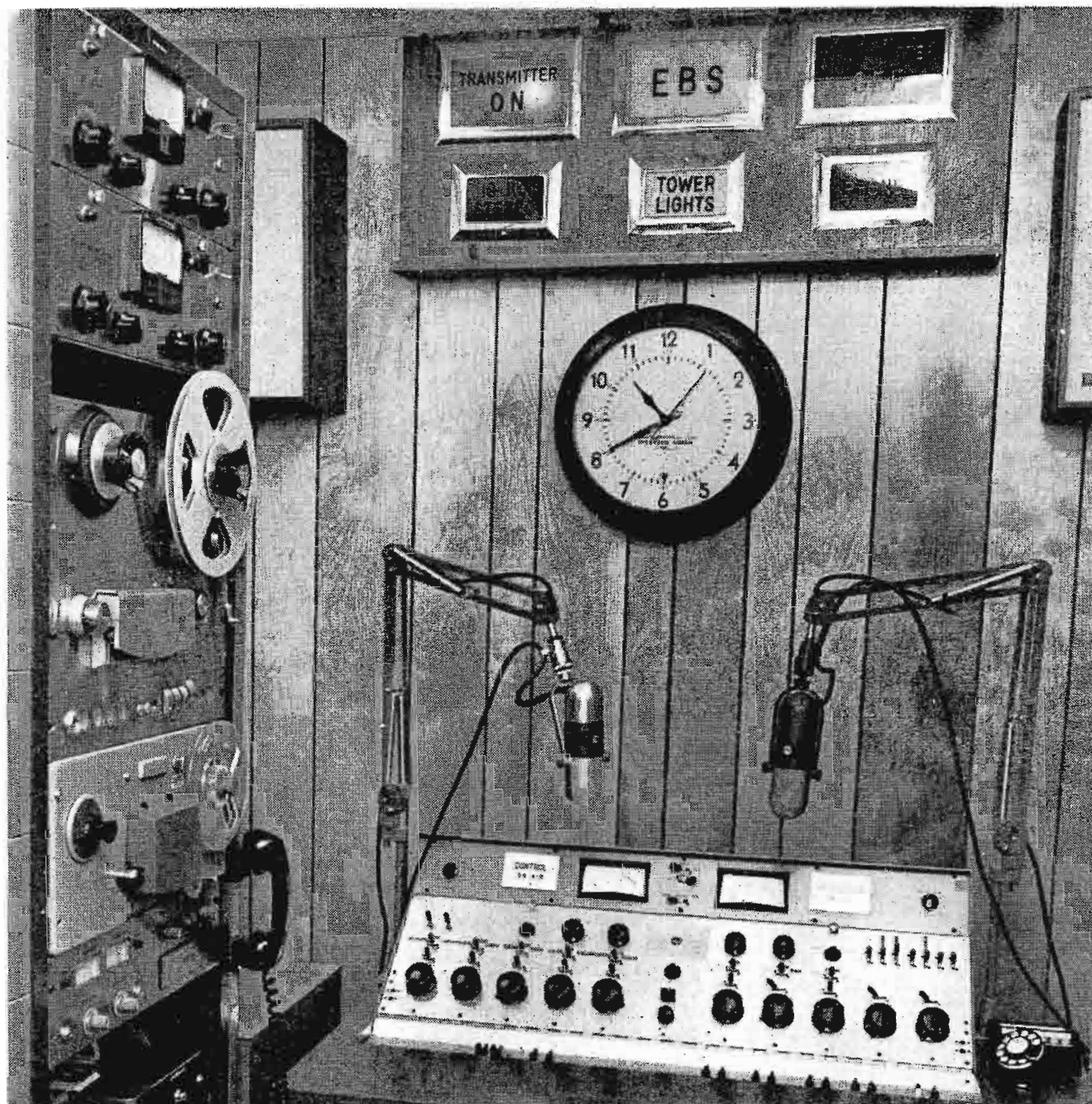
### Transmitter Facilities

An RCA "new look" 10 KW FM Transmitter, Type BTF-10E is installed with type BW-73 FM multiplex monitor, BW-74 Stereo Monitor, and SCA Stereo Generator.

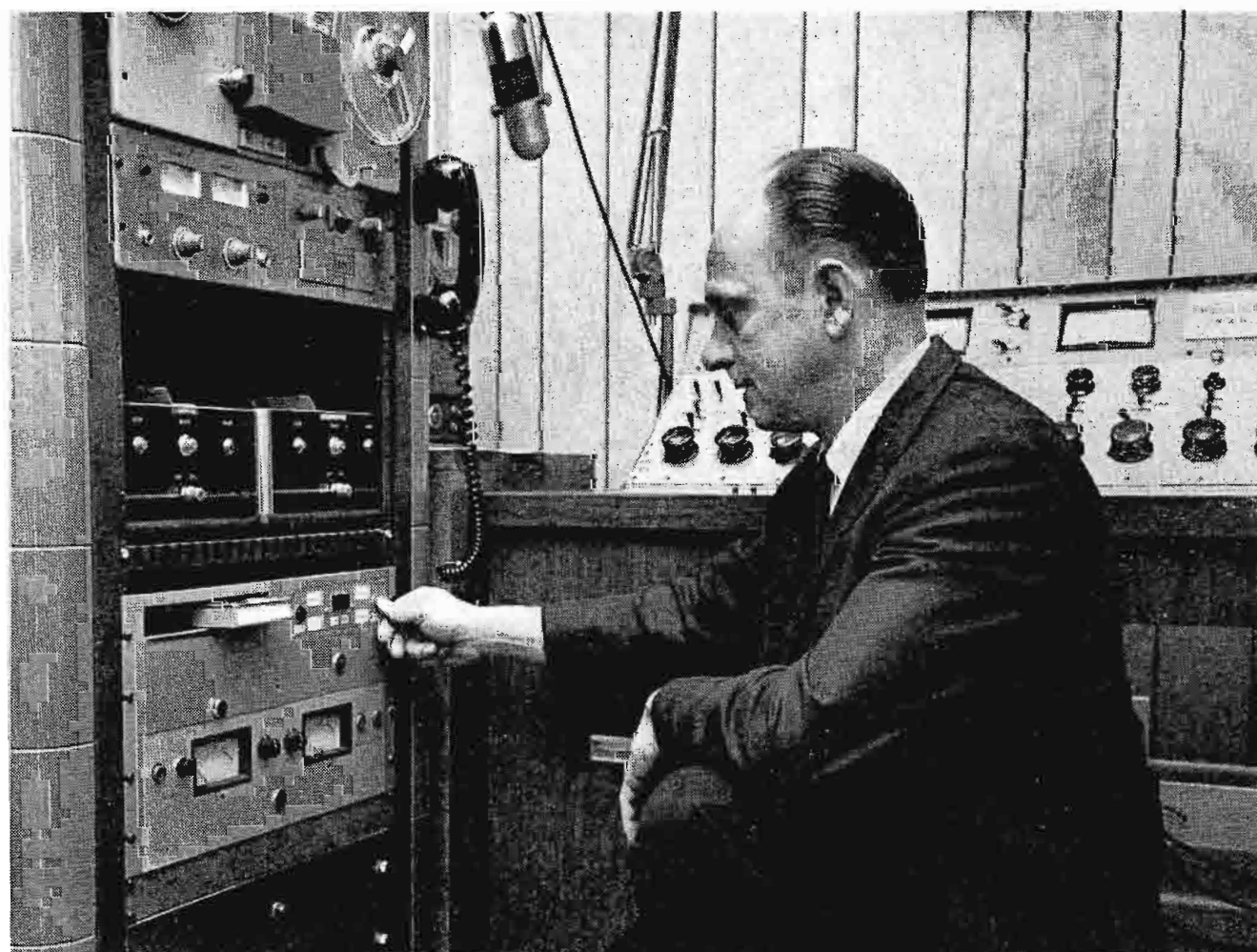
A special pushbutton switch permits a person in the transmitter room to start station ID on tape cartridge in control room for testing.

The exciter, stereo generator, and SCA exciter normally mounted in the transmitter cabinet, have been removed and installed in a rack. This is done in order to eliminate any possibility of vibration.

►  
**FIG. 6.** The production room is where cartridges are made up for announcements, sign-ons, spots, etc. All material is on stereo tape, and some of the spots with musical backgrounds are staff produced. Bud Melton, program director of WMJR-FM is shown operating the RCA transistorized RT-37 stereo cartridge tape recorder.



**FIG. 5.** Production control resembles the main control room in equipment complement and layout. Another BC-7 consolette is used, with the dual 77DX microphones for stereo pickup, stereo reel-to-reel cartridge tape equipment and a disc turntable (not shown). Although the room is designed primarily for production of programming, on-air operation is occasionally delegated to this console.



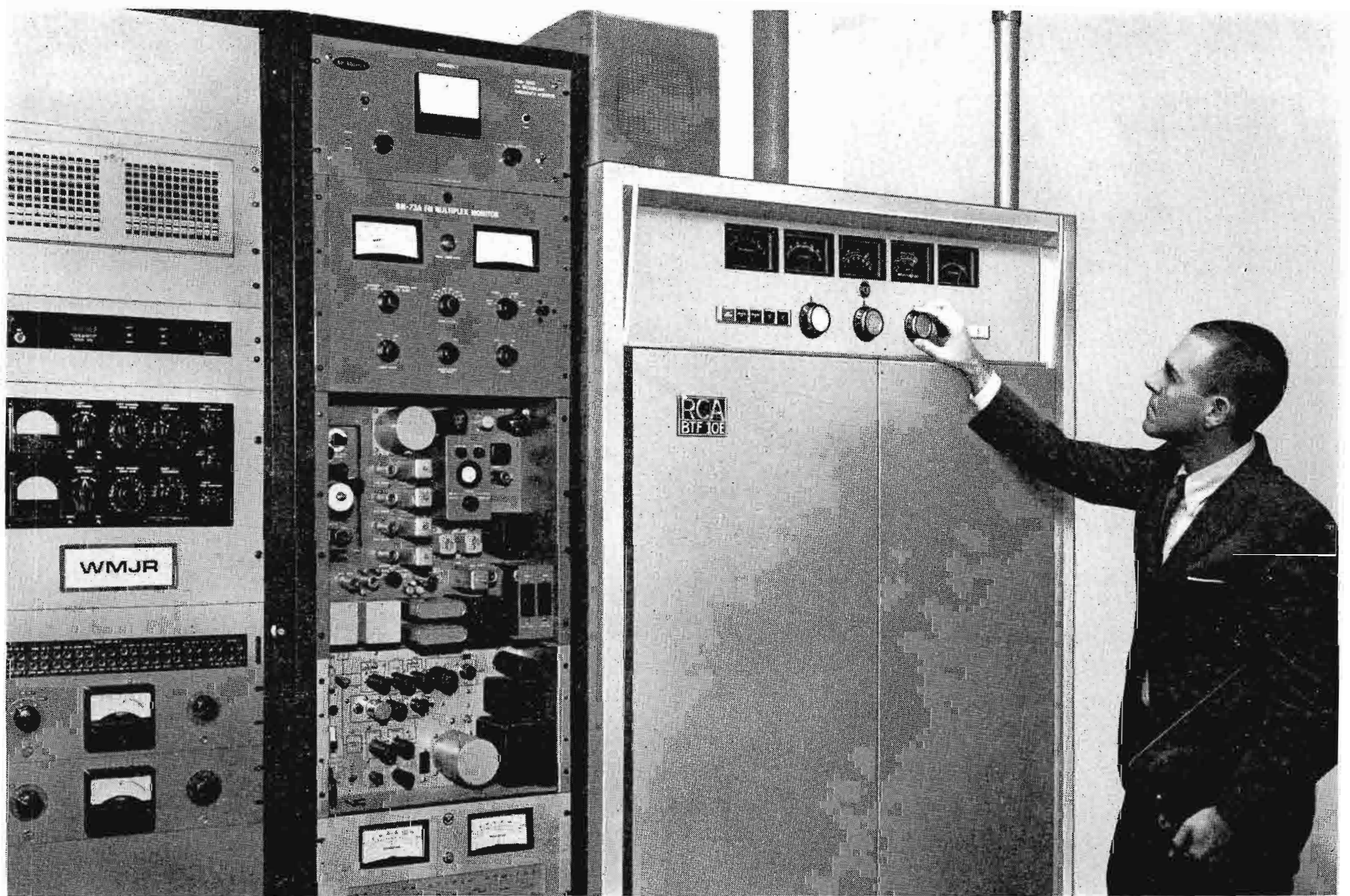


FIG. 7. The RCA BTF-10E ten kilowatt FM transmitter is the latest in New Look transmitting equipment. It is completely self contained (except for an external power supply not shown) and is housed in a modern cabinet, 48 inches wide by 32 inches deep by 77 inches high. Mounted in the rack adjacent to the transmitter are frequency monitor (top unit), multiplex monitor, subcarrier generator, Direct FM exciter, stereo monitor and stereo generator (not visible). Station chief engineer and author of this article, Ron Crider, is shown tuning the transmitter. Plans are to modify the BTF-10E in the near future for 20 kilowatt output.

Also, it keeps cable lengths shorter, especially for use with SCA.

The transmitter is remotely operated from the main control room by the station's own remote system. It is designed to read directly the output power and the actual plate voltage—in addition to the per cent plate current.

#### Installation and Service Simplified

Use of telephone company type termination avoids soldering of the numerous connections necessary for installing rack equipments. These are the regular terminations sold for use by independent telephone companies in which the wire is merely shoved into its terminus by means of a special tool. Connections are speedily made with use of soldering irons.

Use of standard Belden color coded wire also helps to make the job lots simpler. In

the beginning, it takes more time to color code, but it's important in helping to distinguish one channel from another in a stereo operation. Charts are made showing each color code and where it's used. In general:

- Red = Right channel
- Blue = Left channel
- Green = Monaural

This makes tracing of wires and servicing much faster. Further, generous use is made of patch panels and all patch panels are charted.

#### Future Plans

Station WMJR-FM plans to move its transmitter and antenna to a new site in nearby Boca Raton. The antenna will be sidemounted at 1800 foot level of a 2000 foot tower. Vertical and horizontal coverage will be achieved through use of a new RCA BFA-12-Bay antenna.

The BTF-10E 10 KW Transmitter will be modified, increasing power from 10 to 20 KW and erp from 62 to 100 KW. This, it is planned, will improve both signal and coverage.

The studio will remain in its present location, some 12 air line miles from the proposed transmitter site. It is proposed to use a 4 or 5 channel microwave system for studio-transmitter link.

Two microwave channels will serve for the left and right stereo channels. The third is for the proposed SCA service. The fourth is for talk-back and convertible to spare for use in emergency.

Future plans include a mobile remote unit. A VW bus is already available. It is planned to install an RCA stereo console together with microphones, cartridge tape and transcription turntable.

# COMPACT KILOWATTER SERVES HUMPHREYS COUNTY, TENNESSEE

WPHC in Waverly Programs for Almost 20,000 Radio Homes in Tennessee Valley



FIG. 1. Dean Bush and Shirley Kilgore go over accounts in the spacious reception room at WPHC's plant. Master Control is beyond the picture window at left.

Waverly, the county seat for Humphreys County (Tenn.), is located approximately 65 miles west of Nashville. Operating at 1060 kc., WPHC's 1000 watts serves this area with all-local programming.

## WPHC Organization

The station is owned and operated by the Humphreys County Broadcasting Company of which Mr. R. M. McKay, Jr. (of Columbia, Tenn.) is president. Mr. Dean Bush, of Waverly, directs station operations.

## WPHC's Market

The market area of the station covers portions of eight counties in which some 43,000 people live and work. Annual retail sales total more than \$25 million with spendable income of the area running close to \$50 million a year. Although chiefly agrarian, the economy is bolstered by several large industrial installations.

## Station Facilities

WPHC is housed in a new, one-story building which offers approximately 700 square feet of floor space. The construction is brick-veneered concrete block with a pre-stressed concrete roof. Inside partitions are of 6-inch concrete block insulated with glass-wool. Windows in the partitions are Thermo-Pane set in rubber to provide excellent sound insulation. Acoustical tile covers the walls in the master-control room and the studio to damp reverberation.

FIG. 2. WPHC's brick-veneered concrete-block building houses all facilities of the station. The antenna tower is just four feet from the rear of the building. Utility power enters the building underground.



**FIG. 3.** The floor plan for WPHC's plant shows the compact arrangement that works so well. Note the proximity of the antenna tower to the rear of the transmitter room.

### Operating Equipment

Master Control is equipped with an RCA BC-5B Console at the center of the "U" (see floor plan) with two BQ-2C Turntables to the left. Four cartridge tape decks flank the console with two on the left and two on the right. A tape bin and a record cabinet finish out the "U". A BK-1A mike is used for live pickup in the control room.

WPHC's transmitter is an RCA BTA-1R1 located in a separate room (see floor plan) so that the front of the transmitter is visible to the master control operator through a glass-windowed door (see Fig. 3).

The concrete pad for the antenna tower is located only four feet from the building just outside of the transmitter room. This minimizes the length of the transmission line between transmitter and antenna.

Additional recording equipment in the studio augments the gear in Master Control. As a result, WPHC is equipped for virtually any programming assignment. WPHC furnishes remote-programming facilities to its clients and bills only for the extra expense involved in setting-up the remote.

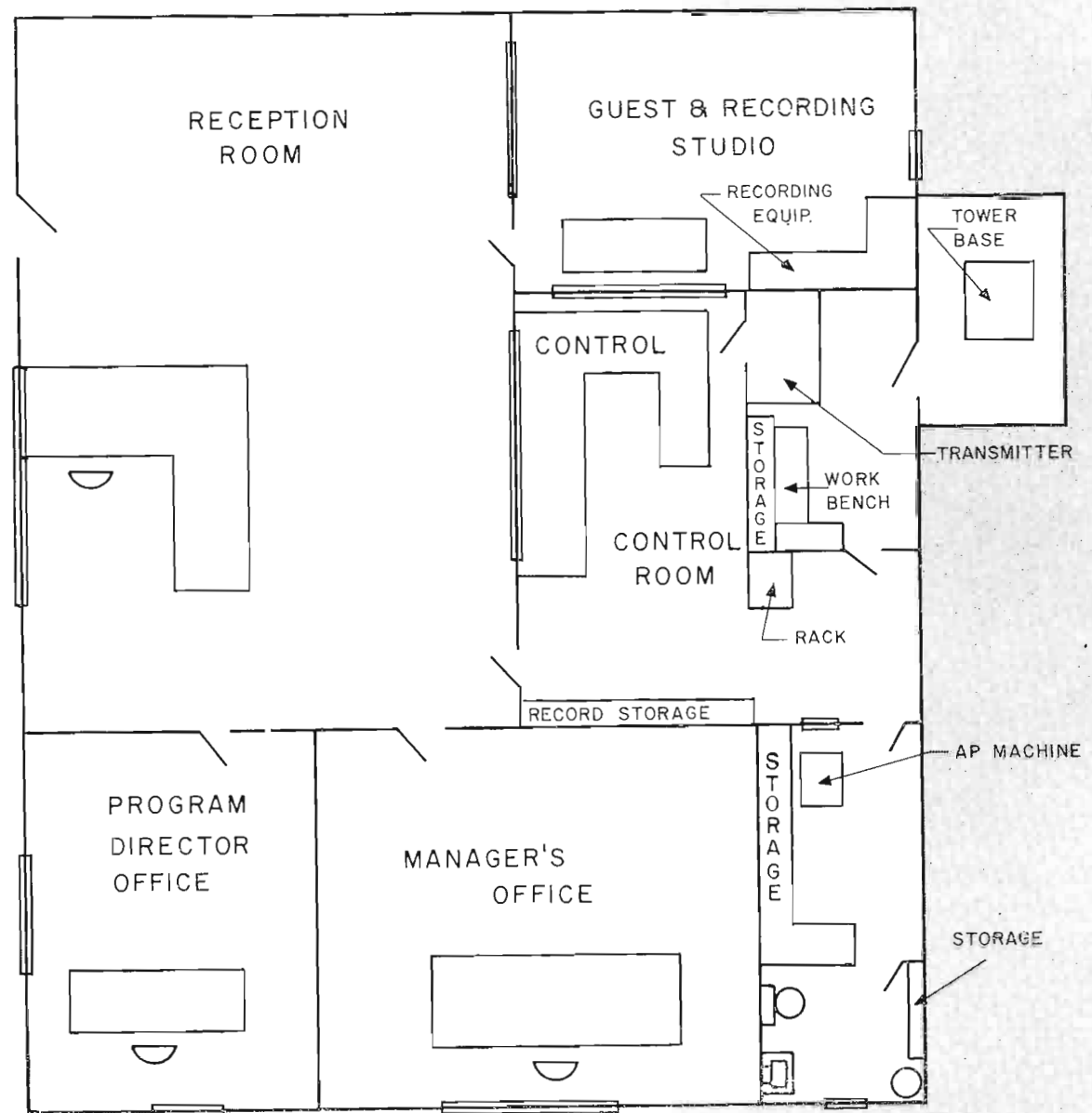
News programming is developed by a complete local and regional news staff. An Associated Press leased-wire service provides national and international news coverage.

### Scientifically-Planned Programming

WPHC's program policy was developed to serve the Humphreys County area. As a result, the audience is an interested and continuous one. This program policy, undoubtedly, is the reason for the station's quick and lasting success.

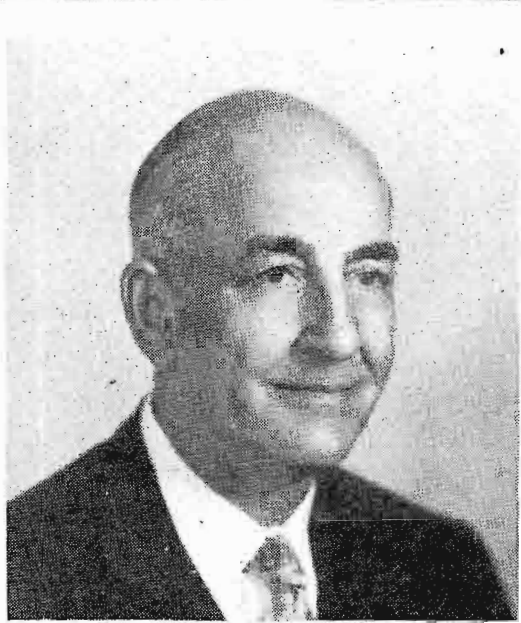
### Model Station

WPHC's operation sets a good example of station design that provides more-than-adequate facilities at modest investment. The equipment layout makes for extremely convenient operation with excellent creative "elbow room" for air personalities. Virtually every inch of floor space is used to good advantage.

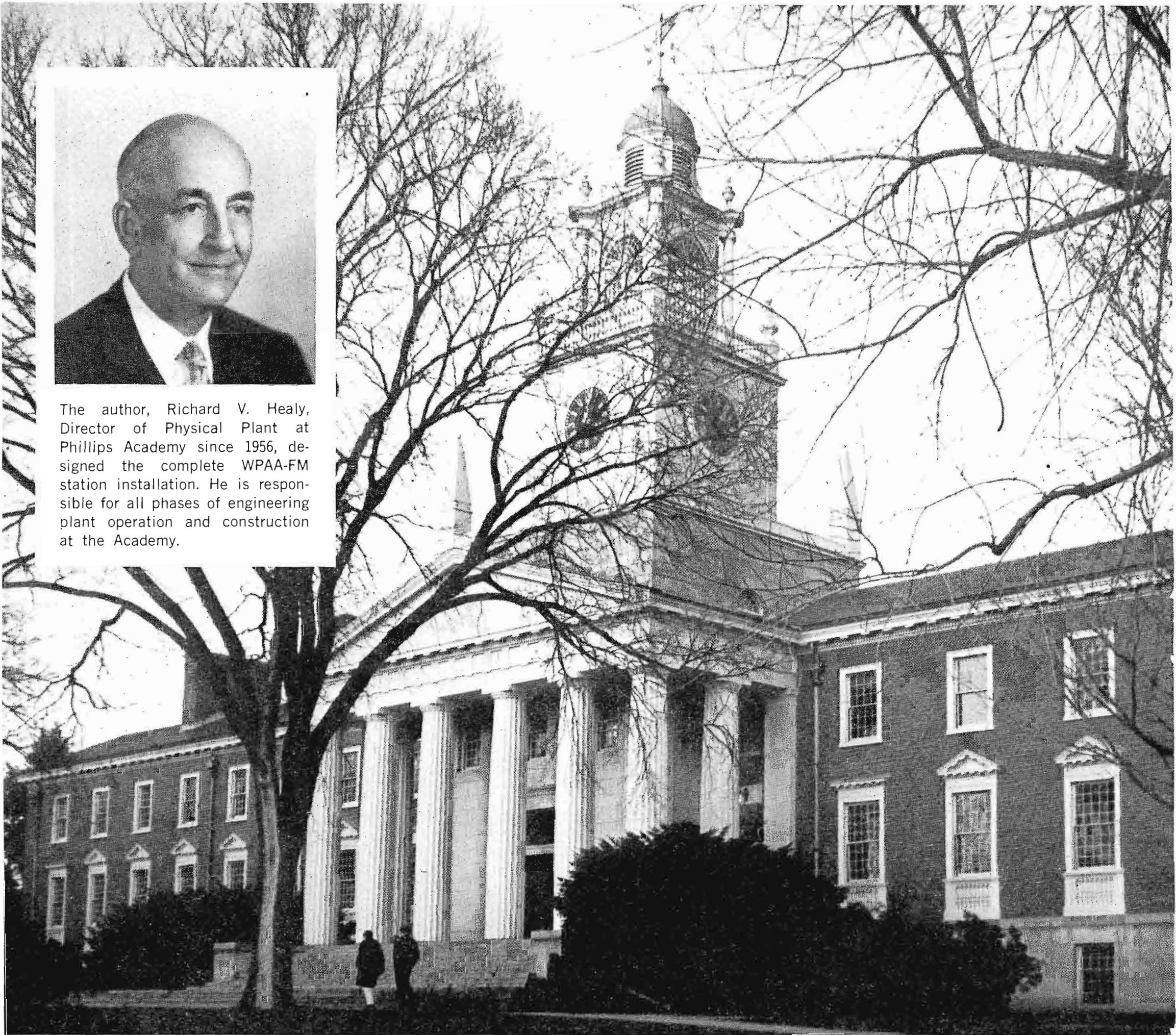


**FIG. 4.** WPHC's Master Control Room. Program director George Vaught returns a "spot" tape to the bin. Joseph Parker, WPHC's news director checks a meter reading on the equipment rack.





The author, Richard V. Healy, Director of Physical Plant at Phillips Academy since 1956, designed the complete WPAA-FM station installation. He is responsible for all phases of engineering plant operation and construction at the Academy.



**FIG. 1.** Phillips Academy was founded on April 30, 1778 in Andover, Massachusetts (23 miles north of Boston) by Samuel Phillips, a Revolutionary War patriot and later Lieutenant Governor of Massachusetts. The Academy is a liberal, modern, non-profit association, non-denominational in faith, imbued with high standards and a tradition of national service and devotion to democratic ideals. This view of Samuel Phillips Hall shows the main recitation building, heart of the school's classroom life. President Coolidge spoke from this portico on May 19, 1928 during the Academy's Sesquicentennial Celebration.



# PHILLIPS ACADEMY BUILDS AN FM RADIO STATION

Student Operated to Provide Broadcast  
Experience and Develop Relationship  
With the Surrounding Community

by RICHARD V. HEALY, P.E.

*Director of Physical Plant  
Phillips Academy  
Andover, Massachusetts*

Radio station WPAA-FM began broadcasting April 1, 1965 on the campus of Phillips Academy, Andover, Massachusetts, the nation's oldest incorporated preparatory school. It is a non-commercial, educational station operating at a frequency of 91.7 MHz with 10 watts power.

The highlight of the dedication ceremony was a pre-recorded program welcoming the new station, narrated by Hugh Downs and featuring Bob Hope, David Brinkley, Jack Lemmon (class of 1943), Sammy Davis, Jr., Don Adams, Bill Cosby, Skitch Henderson, and the Tonight Show Orchestra. Mr. Robert W. Sarnoff, President of the Radio Corporation of America (class of 1935), also took part in the dedication ceremony.

Approximately 100 students in a body of 850 organize and administer the entire operation. This past summer, nineteen students obtained a radio operator's license. The station broadcasts twenty-five hours a week in the regular school year. The antenna on campus is situated 330 feet above sea level and overlooks the entire Merrimack Valley. Transmission extends beyond a ten mile radius to a potential 150,000 listeners. Community response to the station is enthusiastic, as indicated by the number of request calls during broadcast hours. The radio station is an invaluable addition to the resources of the Academy, and to the range of experience for its students.

## **The Original WPAA**

The concept of a student radio station was first developed in 1961 by a small

group of enthusiastic young men interested in the field of communications, and convinced that a campus radio station would be a fruitful addition to campus life. The founders had a sufficient knowledge of programming, an adequate engineering staff, and enough lower classmen to insure continuity of operation. Several students had gained experience working in commercial radio stations during the summer vacation. The project called for each student in his free time to contribute three hours a week to the station. At first, this was thought to be a possible hindrance to the student's regular academic development, but the project provided a creative outlet to students who might not otherwise participate in extra-curricular activities. The administration decided that the group deserved an opportunity to demonstrate and develop their talents. The project was approved for a one year trial period, with the usual provision for faculty supervision. WPAA began in the initiation room of a converted fraternity house. Using discarded furniture, unwanted rugs and draperies for acoustical effects, student-owned radio equipment, parts and supplies from government surplus, and thirty dollars cash reserve, the students began broadcasting.

Since no student had a radio operator's license, the transmitter operated on the citizen's band frequency of 27 MHz with a power output of 100 milliwatts, and converters were installed to deliver the signal to 645 kHz AM.

Late in 1962, the ramshackle facilities were moved to the recently completed

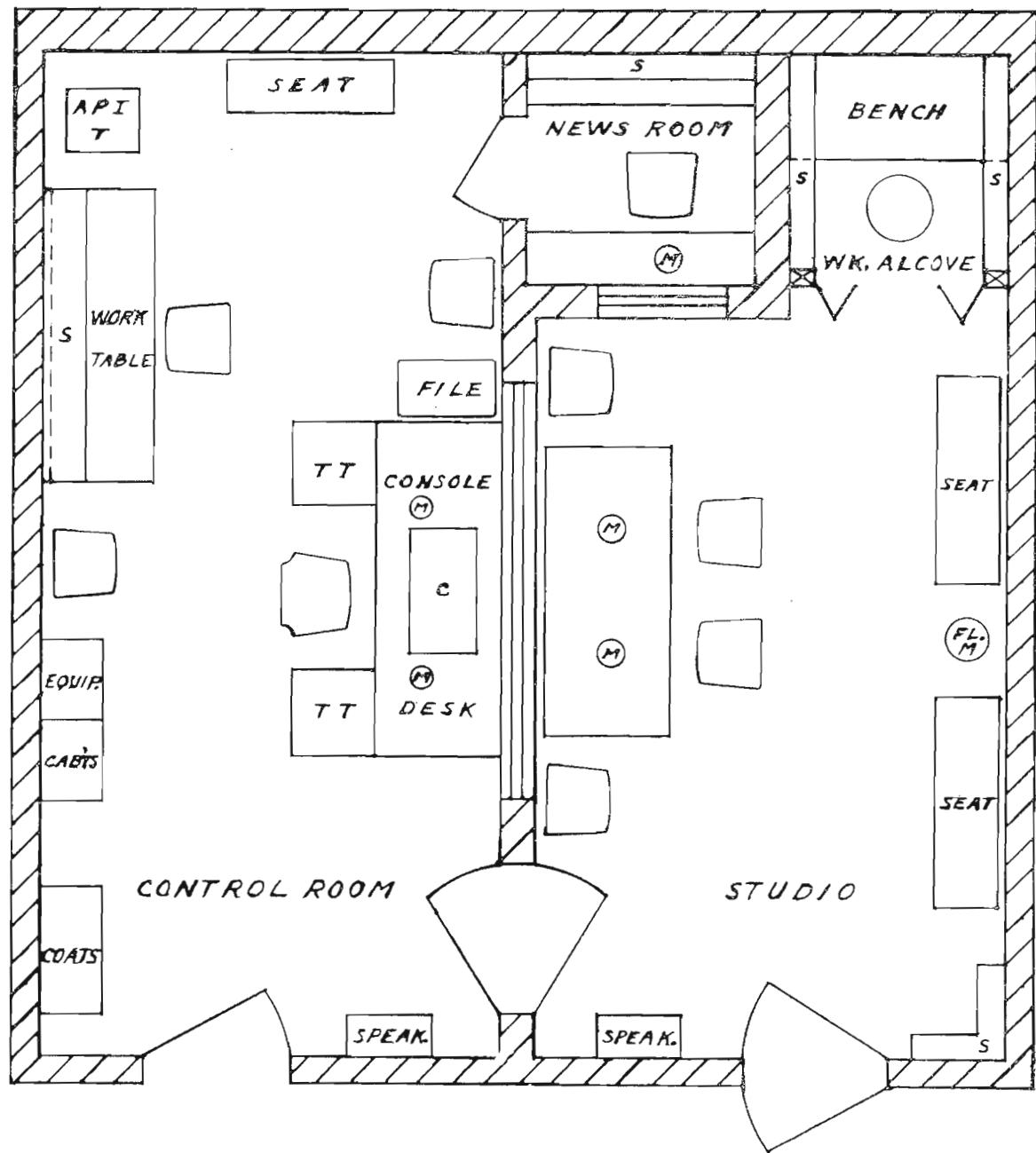
science building, and shared quarters with the school's amateur radio station W1SW. There was little improvement over the original location, although the transmitter was installed in the bell tower of an adjacent building, and connected by subterranean conduit. The large room was subdivided, again using scrap materials which produced a layout little better than in the past. The original group graduated, and the cause was taken up with renewed vigor by the present staff, who hope to accomplish the ultimate objectives of the organization: the development of a relationship between the campus and the surrounding community, and to provide its audience with both educational and entertaining programs as a public service.

## **New Facilities**

In November, 1964, the organization's aspirations were fulfilled when RCA broadcasting equipment was acquired and put into place by its engineers, and supervised by Mr. Edward Herlihy, RCA Broadcast Representative in the New England Area. They were assisted by two capable student staff members, Gregory P. Richards, station manager, and William B. Barker, chief engineer, both now attending Harvard University. The radio station and mechanical facilities to house the operations were designed by the author and constructed by independent contractors.

A recent sampling of program material broadcast to the community may help the reader to gauge the quality and success

**FIG. 2.** View of the Control Room shows a student seated at the custom built Master Control Desk with an RCA Audio Console, two turntables, microphone and storage space. The Control Room also contains API Teletype, equipment racks, work table and extra seating to encourage student interest and participation.



**FIG. 3.** Floor plan of the WPAA-FM radio facilities consisting of Control and News Rooms, Live Studio and Work Alcove. Double doors with a six inch air space between the doors are used to furnish acoustical isolation of the studio.

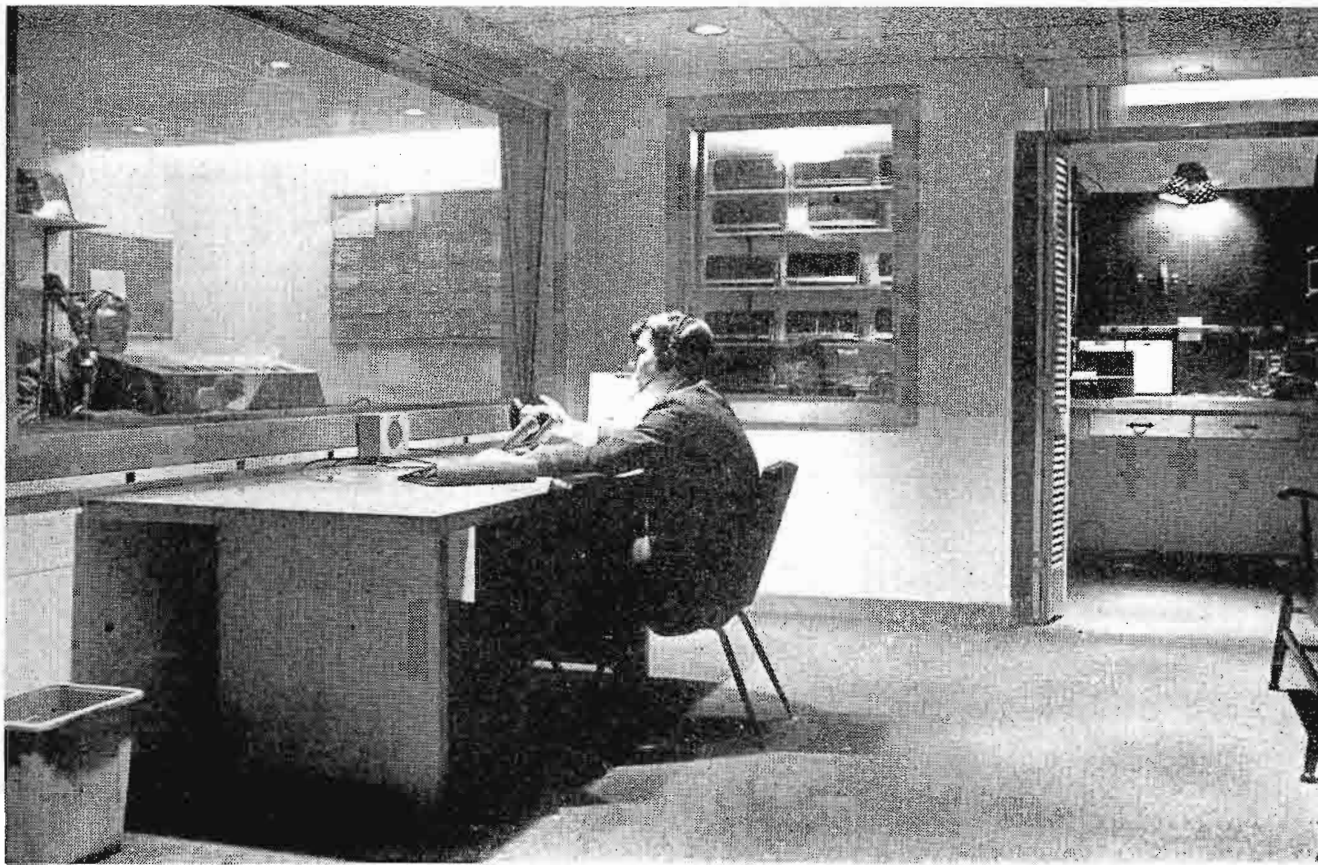


FIG. 4. View of the studio shows a student seated at the table equipped with two microphones. Full visibility is afforded to the studio from the News Room by a double plate glass window. The Alcove that opens into the studio contains a repair bench for student use during non-operating hours.

of the under-taking: *Scope* (United Nations News Service), *Family Theater Spanish Hour*, *Experiments in Education*, *Theodore Bikel - In Concert*, and *Georgetown University Forum*.

#### Station Features

The facilities occupy 600 sq. ft. and consist of control and news room, live studio and work alcove. Figure 3 shows the floor plan. Full visibility is afforded to all sections of the broadcasting operation by large sections of double pane  $\frac{1}{4}$ " plate glass, set in rubber in a V-formation.

Figure 2 shows the 11'-0" x 23'-10" control room which provides adequate space for the custom built master console desk with storage space, two turntables, tape recorders, API teletype, equipment racks, work table, record storage, and extra seating to encourage student interest and participation.

The news room, 5'-6" x 5'-6", opens into the control room, and is isolated from the studio by a double plate glass window, mounted in rubber and shaped in the form of a V. The microphone counter faces the window, and full visibility is afforded to the studio's operations. On the rear wall are located storage shelves and a work counter. The compact size is adequate for the studio's needs.

Figure 4 shows the studio which is of sufficient size (11'-3" x 17'-6") to accommodate fairly large groups for a variety of live performances. It is equipped with a floor microphone and two table microphones. To utilize all available space, shelves are located in one corner of the room for future tape and record storage.

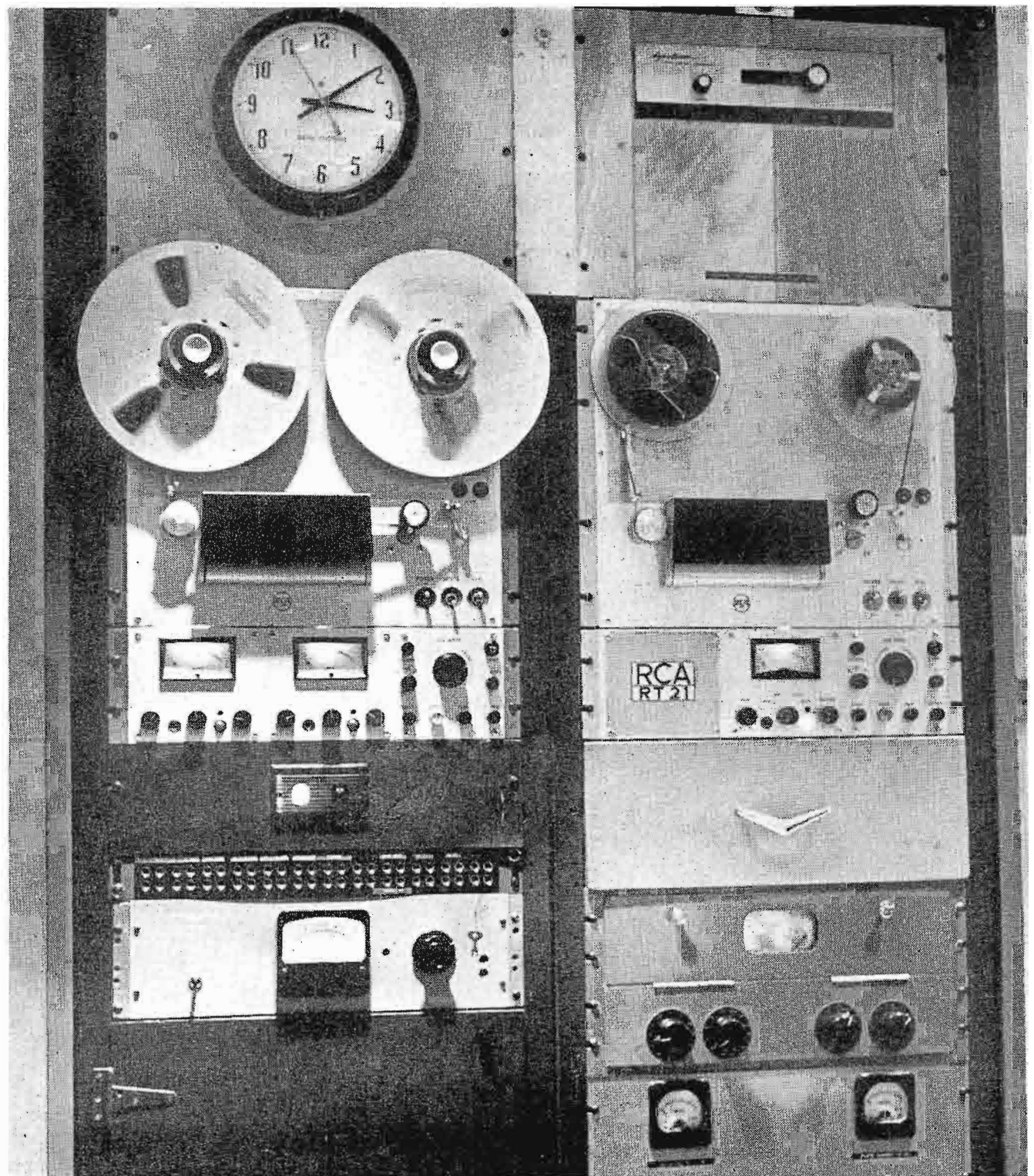
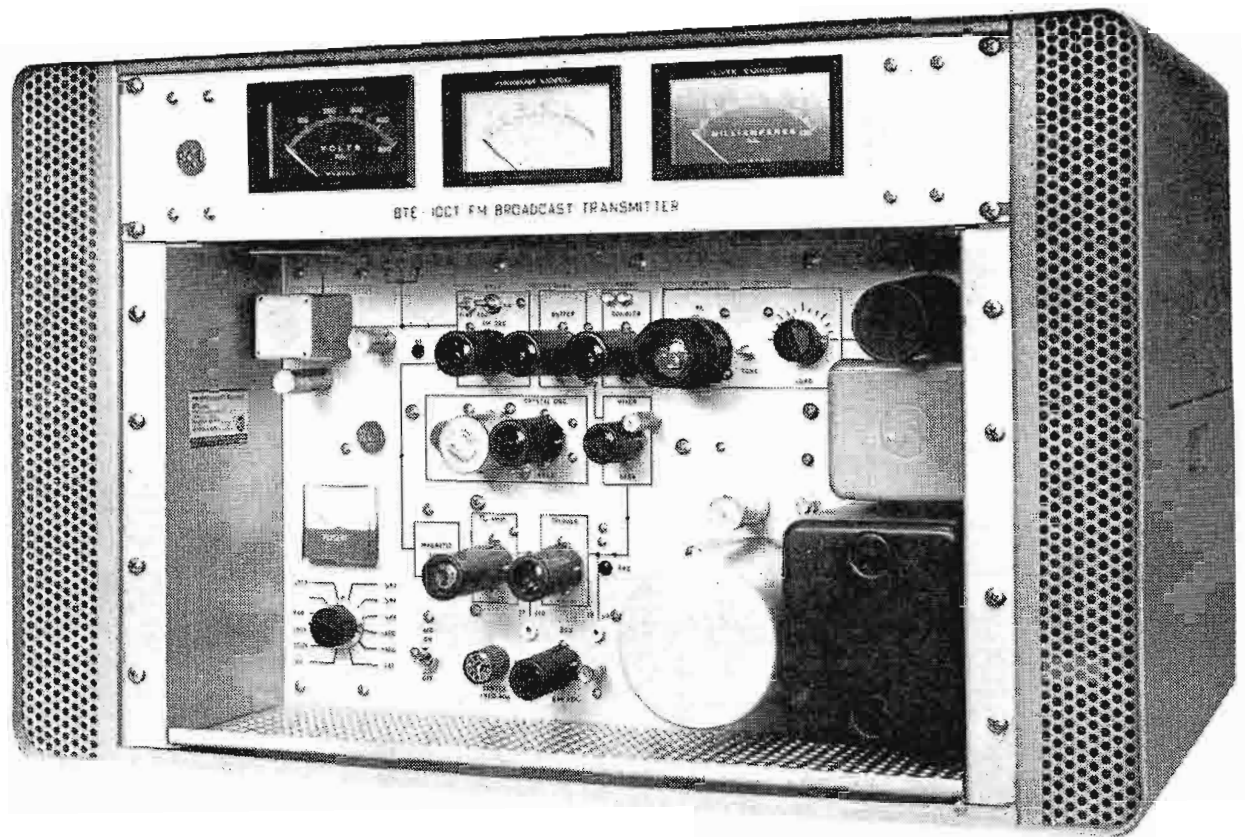


FIG. 5. The equipment racks located in the Control Room contain monaural and stereo tape recorder systems, audio control equipment and remote monitoring equipment.

**FIG. 6.** The WPAA-FM transmitter, located in a rooftop penthouse, is an RCA BTE-10CT FM Broadcast Transmitter. It conforms to FCC requirements for educational transmitters and provides 10 watts output.



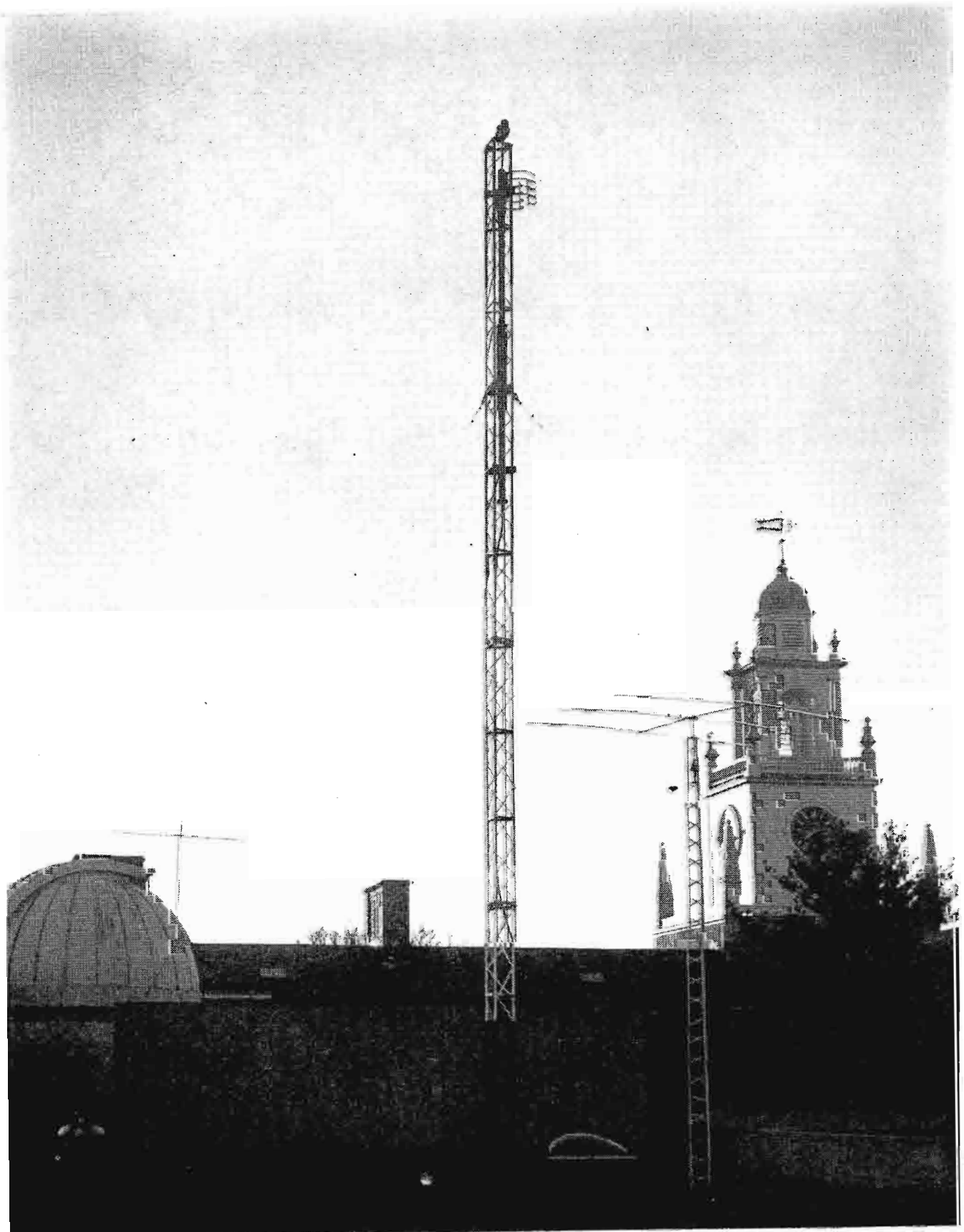
The 5'-3" x 5'-6" alcove contains storage shelves along the side walls, and a repair bench for student use. The alcove opens into the studio.

The standard inter-communications system from the RCA consolette to the news room and studio was expanded by adding intercom units in the corridor outside the control room and near an entrance on the outside of the building, and in a roof top penthouse where the transmitter is housed. Each location is indicated by colored lights on the consolette. Another feature of the system is the addition of remote control elements on the consolette to operate two professional tape recorders mounted in racks on the rear wall. Telephone connections are provided directly to the consolette for possible broadcast of major off-campus events. The operator of the consolette has a swivel unit microphone on a special stand for right or left-hand operation.

#### **Conclusion**

This article provides a nucleus of ideas for the concept of a student-run radio station. The field has had little development, but offers many possibilities for both the school and the student to learn and to develop a relationship with the surrounding community in the interests of communications and public service.

**FIG. 7.** The antenna is a single section of RCA BFA Broadband FM Antenna mounted on a guyed tower. The lower antenna is for the Phillips Academy Amateur Radio Station W1SW in operation since 1923. Samuel Phillips Hall is in the background.



RCA  
NEW  
LOOK



AUDIO SYSTEMS... SOUND THE RIGHT NOTE!





**Completely transistorized...  
with modular construction and  
automatic operating features**

## **RCA audio is the right choice for the bright sound!**

### **AUDIO FOR AM, FM, TV**

RCA's pioneering in space-age electronics has paved the way for a whole new generation of audio equipments. There's a complete line of cartridge tape equipment—and reel-to-reel recorders, new Universal turntable, audio relay switcher. Also a new line of audio amplifiers and an automatic programmer.

### **CONSOLETTES FOR FLEXIBILITY**

Choice of four consolettes—from a four-mixer, 20-input equipment to the very versatile deluxe console for dual channel and FM stereo use. They all use plug-in chassis for custom-tailoring to needs and flexibility in operation.

### **TAPE RECORDERS WITH AUTOMATIC CUEING**

Cartridge tape equipments have plug-in tape decks for versatility. They include tone-cue operation—a stop cue, end-of-message cue, and trip cue. And now, even the reel-to-reel types include these cue features, assuring semi-automatic operation between recorders. All these tape equipments are available in both monaural and stereo types.

### **AUTOMATIC PROGRAMMING**

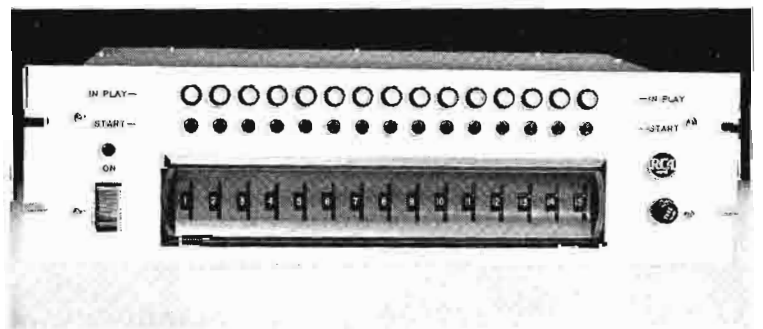
Designed to program fifteen events from any 18 program sources. Number of events may be increased with ease by adding these Programmers in series.

### **THE "NEW LOOK" IN AUDIO**

This is the audio equipment with the RCA "New Look". It costs less to install and less to operate . . . provides highest flexibility. You would expect the best from RCA with its years of experience in radio and television.



*Plug-in chassis give flexibility to consolettes.*



*Automatic programmer handles 15 events from 18 different audio sources.*



*Cartridge tape features cue tone operation.*

RCA  
NEW  
LOOK



FM TRANSMITTER... ALL NEW CIRCUITRY





*RCA 20-KW FM transmitter  
has same cabinet as 5-kw and 10-kw.*

## **“NEW LOOK” FM Transmitters with new circuits for operating simplicity and full fidelity sound**

### **COMPLETE RCA LINE**

**1KW—5KW—10KW—20KW—40KW**

#### **NEW STYLING**

Convenient new height, with eye-level metering and space-age colors combines operating convenience with modern decor.

#### **BIG BRIGHT SOUND WITH “DIRECT FM”**

“Direct” system used in all RCA FM transmitters was pioneered by RCA from the very first. Now uses new, simple FM exciter. Provides superior performance under stereophonic as well as monophonic and SCA conditions, resulting in full fidelity

#### **ULTRA STABLE . . . EASIER TO TUNE**

New simplified circuits and clean open design make tuning easy—provide high degree of reliability required in today’s most modern FM operations.

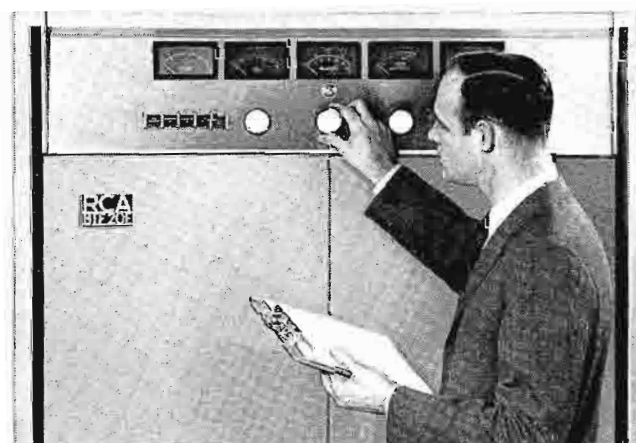
#### **ADVANCED TECHNICAL FEATURES**

Built-in remote control . . . solid state power supply . . . fewer components, better accessibility. No FM transmitters of comparable power have fewer parts or better accessibility.

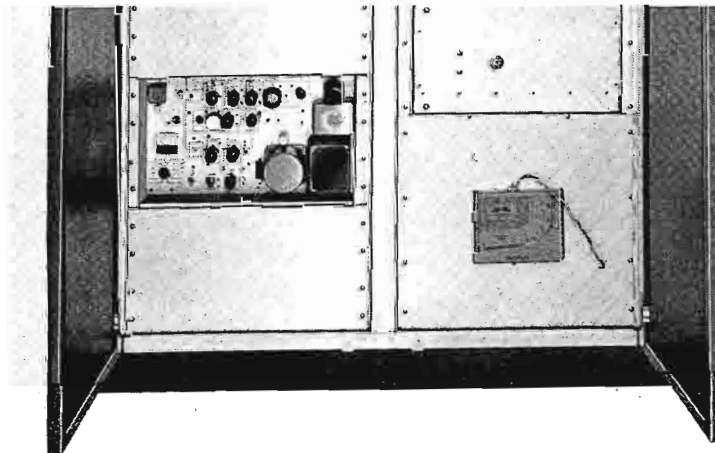
#### **EASY POWER EXPANSION**

All three transmitters are housed in identical enclosures. Field modification of 5-kw, or 10-kw to a higher power requires only a change in basic power-determining parts.

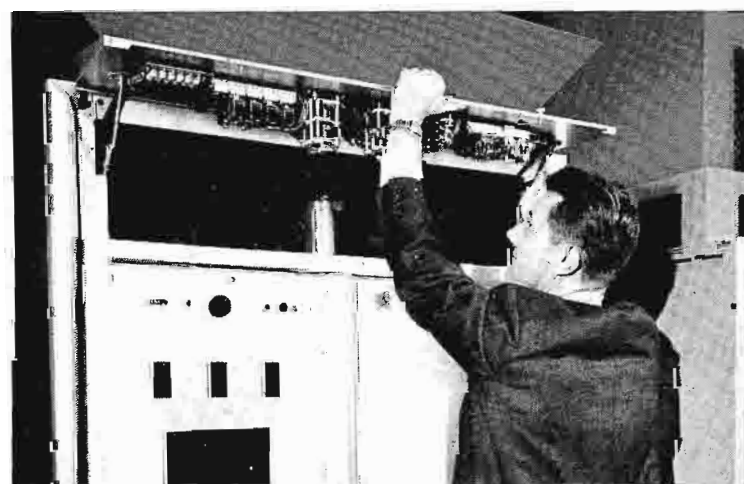
**COMPLETE LINE OF ANTENNAS**—Matched FM antennas . . . vertical and horizontal polarization . . . increased power handling capability . . . broader bandwidths.



*Simplified circuits and open design make tuning easy.*



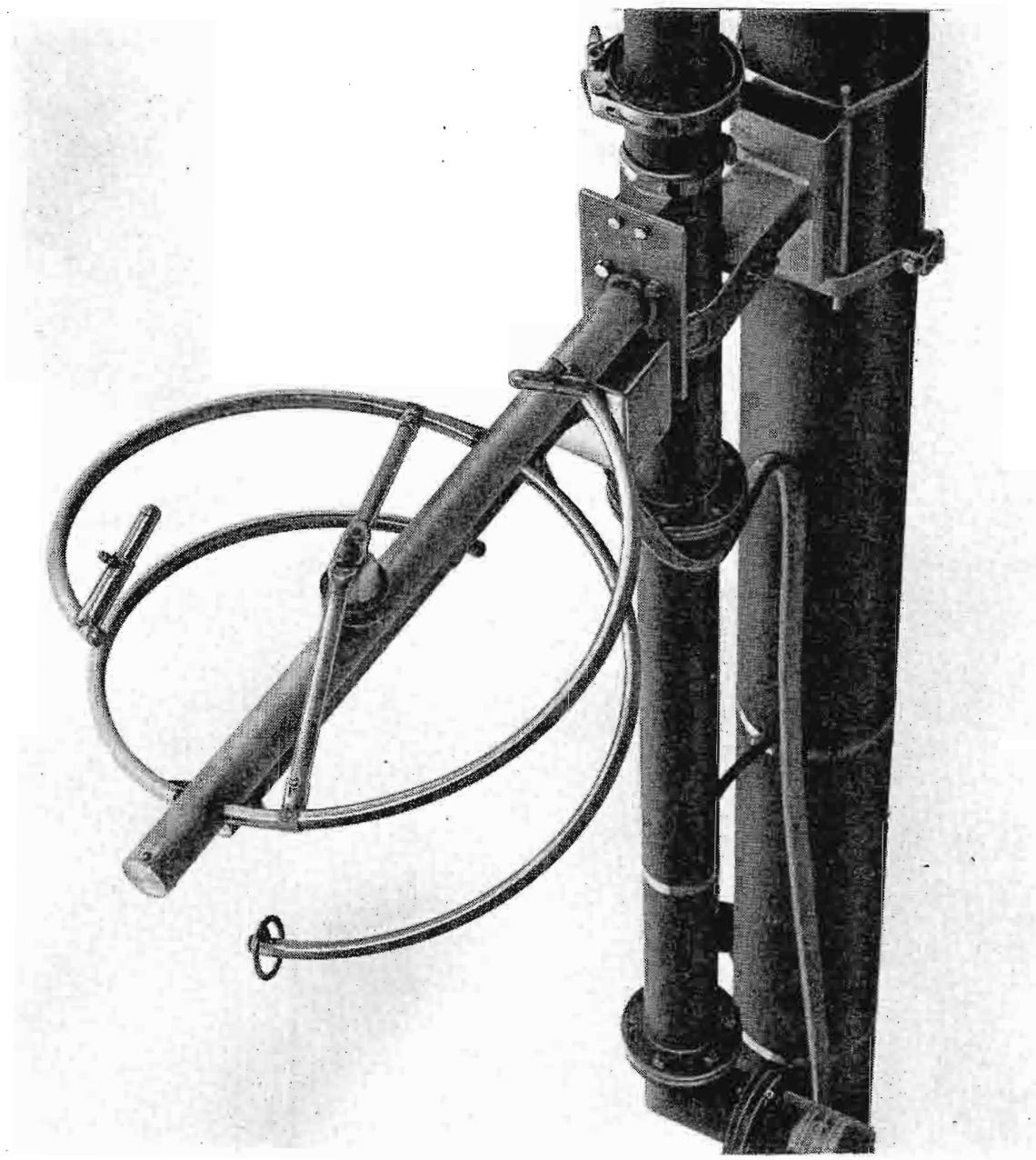
*All new FM exciter, far more simple, far more stable.*



*Transmitters feature easy access to all areas.*



FIG. 1. Type BFC FM Antenna, single, compact antenna costs less, offers lower windloading and achieves performance comparable with or superior to the best combined Vertically and Horizontally polarized antenna systems.



## NEW CIRCULARLY POLARIZED FM ANTENNA

by G. G. STRUBEL

*AM-FM Antenna Product Analyst*

Development of the RCA Series BFC Circularly Polarized FM Antenna represents a significant advance in FM antenna design. The BFC eliminates the need for separate vertically and horizontally polarized radiators since it combines in one antenna all the advantages of each plane of radiation. The new BFC antenna may be side mounted on a tower or pole mounted on the top of a tower or other structure just as combined vertically and horizontally polarized antennas are mounted. In addition the antenna radiates a truly circularly polarized wave which should provide the best received signal in randomly polarized receiving antennas.

### Design Features

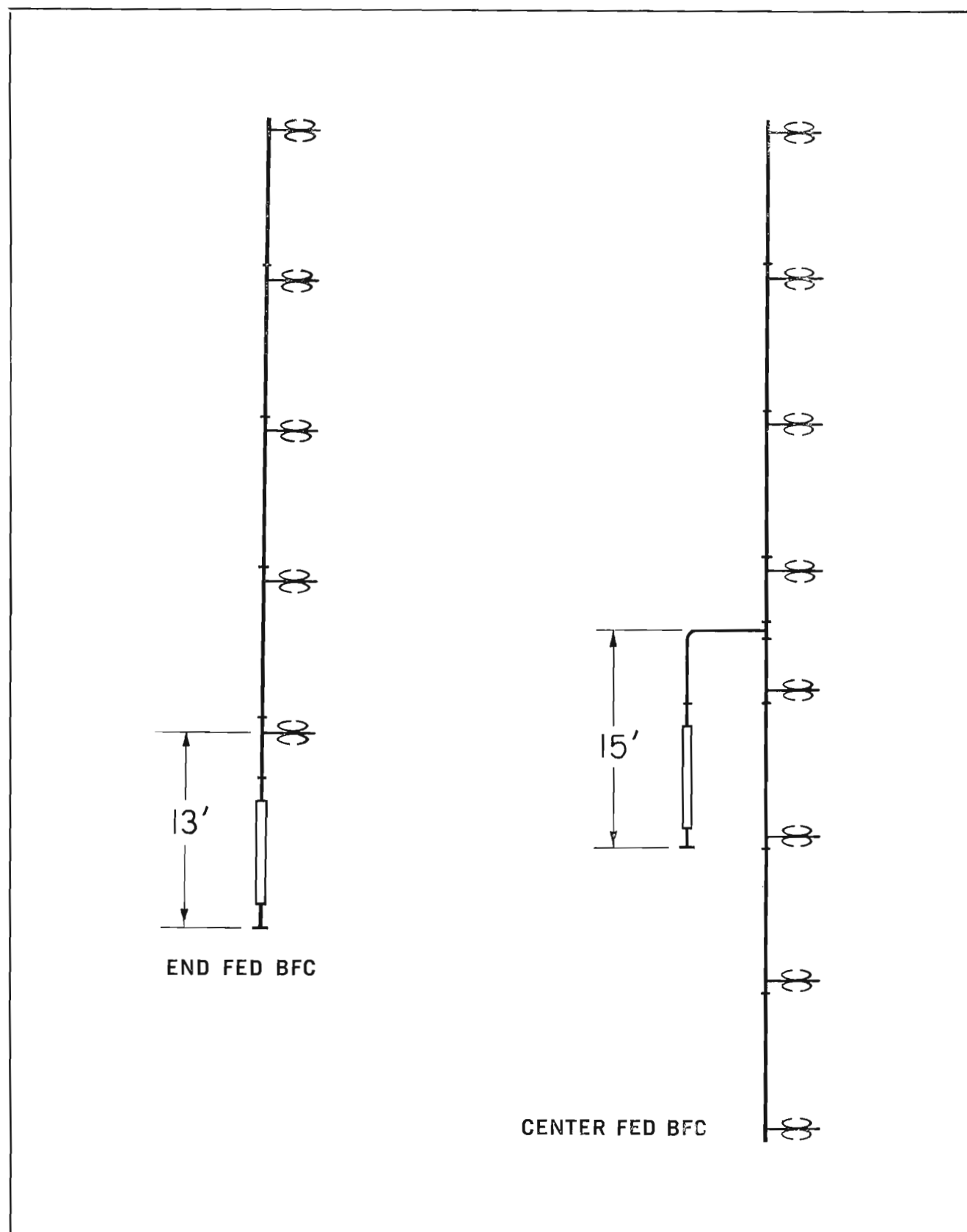
Each bay of the BFC Circularly Polarized FM Antenna consists of two intersecting semi-circular, shunt fed radiators. Construction details can be seen in Fig. 1. The mounting for the two radiators is made up of a short section of stainless steel  $1\frac{5}{8}$ -inch transmission line which includes the Teflon end seal. This line is supported by a single  $3\frac{1}{8}$ -inch copper coaxial transmission line which is used to feed power to other bays of the antenna.

BFC antennas with one to six bays (BFC-1 through BFC-6) are normally supplied end-fed, and those with seven to

16 bays (BFC-7 through BFC-16) are center fed. The input for end-fed antennas extends 13 feet below the center of the lowest bay and the input to center fed antennas extends 15 feet below the center feed point. An adjustable input transformer is contained in this distance. See Fig. 2. BFC antennas can be provided with null fill and/or beam tilt characteristics.

### Cost Savings

Regardless of the number of bays, the BFC is much more economical than the equivalent combination of vertically and horizontally polarized antennas. Savings range from \$2500 to \$6500 depending on



**FIG. 2.** Simplified diagrams show locations of the feedline inputs for both end-fed and center-fed BFC antennas. BFC types having one to six bays are end fed, and seven to 16 bays, center fed. The antenna feedline is  $3\frac{1}{8}$ -inch copper coaxial line.

the size of the antenna. For example, a six-bay circularly polarized FM antenna (BFC-6) costs \$3965 less than a six-bay horizontally polarized antenna (BFA-6B) in combination with a six-bay vertically polarized antenna (300-6V). Because the BFC antenna has half the number of radiators, only one feed line, and no combining network, installation costs are roughly half that of an equivalent combined vertically and horizontally polarized antenna system. Mounting brackets for use with average towers are included at no additional cost.

#### Low Wind Loading

Compared with combined vertical and horizontal antennas, the BFC imposes a substantially lower wind load. For instance, the six bay BFA-6/300V-6 combined verti-

cally and horizontally polarized antenna has a wind load of 1898 pounds (based on 50/33 psf for true extreme wind velocity of 110 MPH), while under the same conditions, the BFC imposes a loading of only 726 pounds, a reduction of 1172 pounds.

Several benefits arise from the low wind loading of the BFC antenna. In many instances it is possible to use lighter, less expensive towers. Alternatively, stations now unable to install combined vertically and horizontally polarized antenna systems because of limitations of existing towers may be able to take advantage of the circularly polarized antenna and its lower load requirements. The BFC also offers large savings in the cost of poles for top-of-tower mounting. This, together with the savings in antenna and installation costs

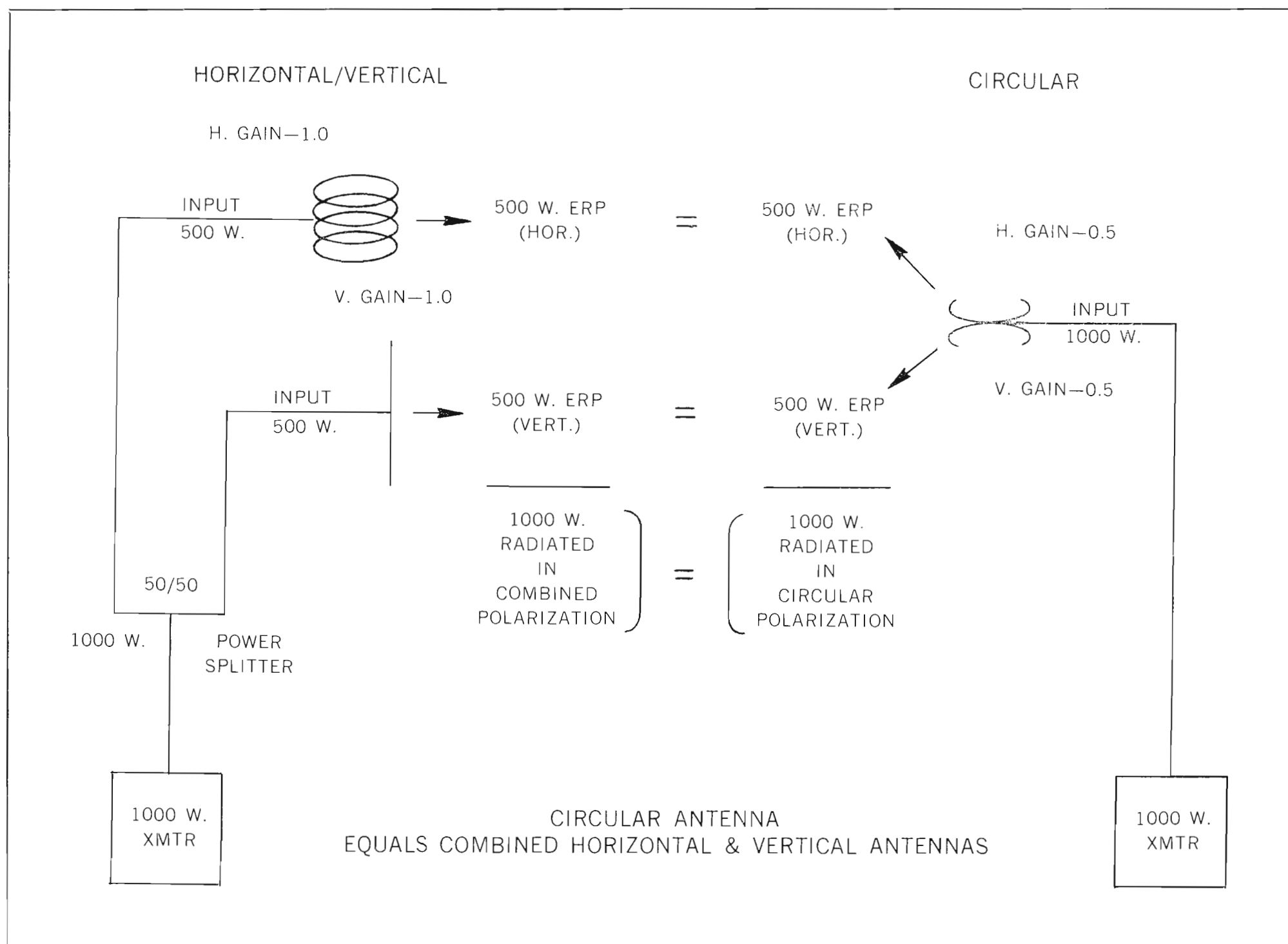
previously shown, should prompt consideration of top mounting wherever possible because of its ability to remove many of the pattern uncertainties attendant to side-mounting of FM antennas.

#### High Power Capability

Input power rating of the BFC antenna extends to approximately 40 kW per bay, which is the limitation of the  $3\frac{1}{8}$ -inch feed system. For input powers higher than 40 kW, antennas with five or more bays can be center fed with a larger diameter input line.

#### Increased Reliability

The BFC antenna employs half as many parts as dual polarized antennas. This design simplicity is certain to increase the long term performance and reliability as



**FIG. 3.** Illustration comparing power division between horizontally and vertically polarized radiation for the combined antennas, left, and BFC circularly polarized antenna, right. No power splitter is required for the BFC antenna, and it has many other advantages as noted in the text.

well as reduce maintenance requirements. Radiators are constructed of stainless steel, and they are heliarc welded because of the superiority of this welding process over silver soldering. The single line feed system consists of modified lengths of RCA 3 $\frac{1}{8}$ -inch, Teflon insulated transmission line, plus an adjustable transformer section and the standard, 50 Ohm EIA flanged input fitting. All feed line flanges are likewise heliarc welded for long term life without leaks and with minimum annealing of the line near the flanges.

#### Ideal for Stereo and SCA

The BFC antenna provides the excellent bandwidth and low VSWR considered necessary for high quality stereo and SCA operation. The single input transformer located just below the antenna can be adjusted at installation to provide a VSWR

of 1.1:1, or better, over the entire 200 kHz. Even without this field trimming, the VSWR will not exceed 1.5:1.

#### Antenna Power Gain

The BFC circularly polarized antenna in effect radiates half its output in vertical polarization and half in horizontal polarization. Thus the power gain in either plane must be considered as half that of an equivalent BFA antenna. However, the gain of one BFC bay is approximately equal to one BFA horizontally polarized bay used in combination with one 300 V vertically polarized bay. This relationship is shown in Fig. 3. Therefore, stations wishing to replace BFA/300V combinations with the new BFC antenna, while retaining the same gain performance, may obtain a BFC antenna with the same number of bays as the existing installation.

#### Circular Antennas In Use

BFC circularly polarized FM antennas are now in operation at WMMR, Philadelphia (formerly WIP-FM) and KMET, Los Angeles (formerly KLAC-FM). The WMMR antenna is a BFC-4 four bay type. The antenna at KMET is a seven bay EFC-7 incorporating both beam tilt and null fill.

#### Conclusion

The new BFC antenna is an efficient, compact FM radiator designed to meet the needs of FM broadcasters. It provides the special type of radiation coverage presently obtained only by combining horizontally and vertically polarized antennas. The fact that this one antenna does the work of two, means a lower antenna cost, lower installation costs, minimum tower loading, and a much simpler installation.

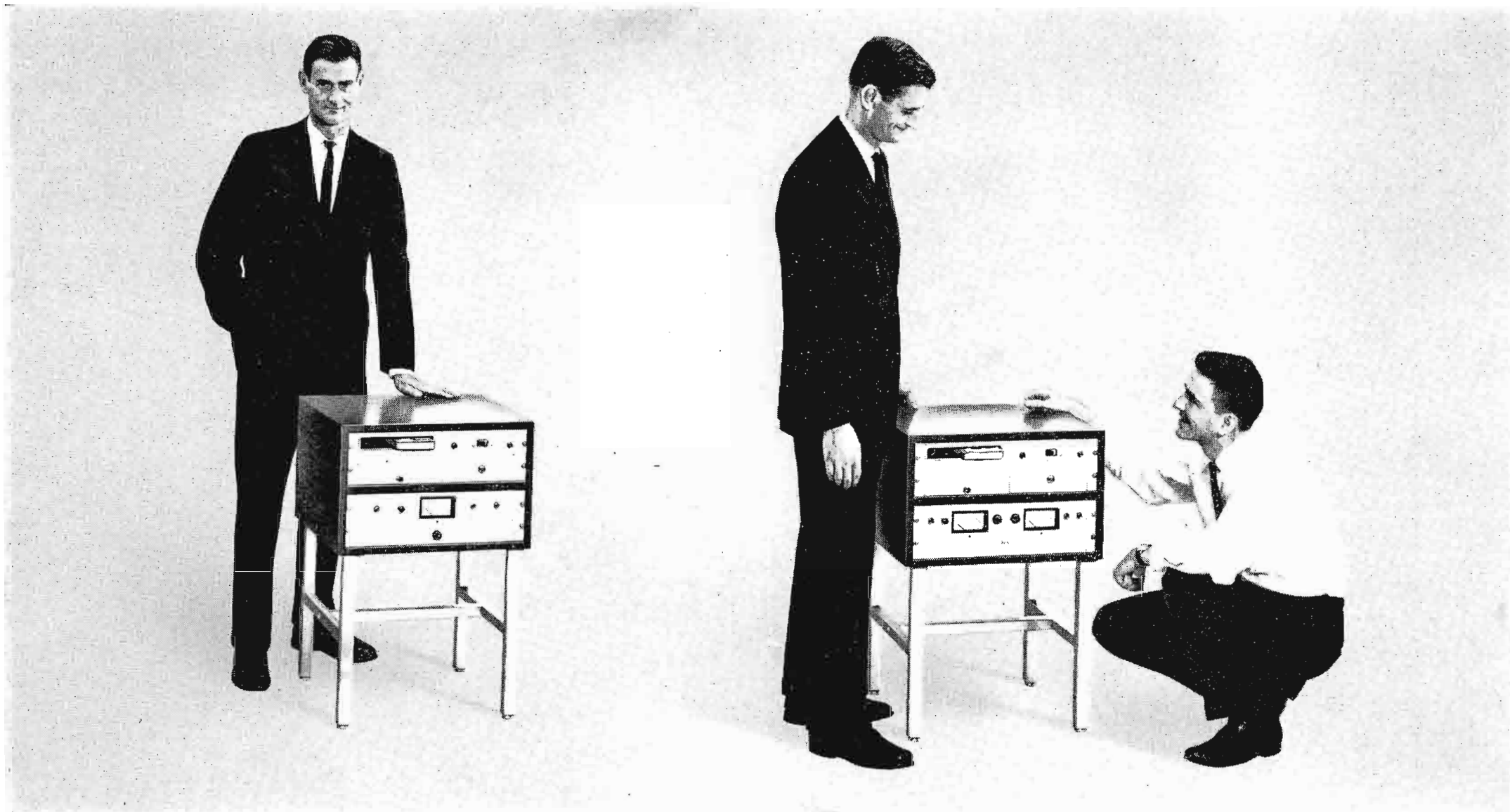


FIG. 1. RCA RT-17 monaural and RT-37 stereo cartridge tape systems. RT-8 multicartridge system not shown.

# SIGNAL-TO-NOISE MEASUREMENTS IN AUDIO TAPE RECORDERS

Latest NAB Standards Establish "0 dBm"  
to Aid Industry in Making Tape Measurements

For those who are confused about recorded levels and signal-to-noise measurements in audio tape recorders this article may help clarify things. It defines the new NAB Standards. These standards at first glance may seem relaxed, but they are actually tighter than before because of changes in the meaning of the word "signal" as explained in this article.

Since the signal-to-noise figure is the ratio between signal and noise amplitudes, two measurements are required. These are easily made in normal audio transmission circuits. Noise is not difficult to measure properly, and with adequate shielding and proper grounding can be made quite low. The main problem, however, in tape recorder measurements is not with noise, but is in the understanding of what constitutes the "signal."

#### Audio Signal Levels

There is a standard signal level of +18 dBm. This is used in broadcast audio

and telephone line measurements. It is measured by VU meters calibrated to read "100%" at an actual level of only +8VU, or 10 dB less than the standard +18 dBm. This is done to allow for the higher level of the true peaks. Therefore, audio amplifiers and circuits are actually tested at a level 10 dB higher than that at which they are used. The point is, however, they are measured at absolute levels.

Unfortunately, absolute measurements cannot be applied to audio tape recorders (nor to optical sound tracks in film



FIG. 2. RCA RT-21B reel-to-reel tape equipment mounted in cabinet rack and in convenient mobile console.

projectors) because the tape produces no electrical power for measurement. A new definition, therefore, is needed for magnetic tape recorders.

#### Magnetic Tape Signal Levels

Though absolute measurements are a problem with magnetic tape, *relative levels* are easily measured. Given two separate recordings of a 1,000 Hz tone, an experienced technician can determine the correct ratio of levels. However, if the same technician is asked to measure an absolute level of either recording, the best we might expect is a reference of so many dB above or below the 3 per cent total harmonic distortion (THD) level.

#### NAB Standards

There have been several reference levels used in tape recording, including the NAB Standard issued in 1953 and the new NAB Standard of 1965. The 1953 standard used a 400 Hz tone recorded at 2 per cent THD. Most tape machine manufacturers preferred a 3 per cent THD because it was easier to obtain accurate measurements. Their definition of the "signal" portion of the S/N was 400 Hz recorded at the 3 per cent THD level.

However, this level\* was at about  $+6\text{VU}$  and thus off-scale on the recording VU meter.

The new 1965 NAB Standard makes two significant changes in previous tape measurement techniques. First, it selects a reference level that is independent of distortion measurements. This level is officially known as the "NAB Standard Reference Level." Secondly, it provides for noise measurements relative to program level. The intent of the NAB Standard is to establish a new level for recording programs. It corresponds to 0 VU (100%) meter reading.

The new "NAB Level", as we call it in this article, is in effect, a sort of "0 dBm" for tape measurements. Figure 5 locates the NAB Level in a range of tape signal levels.

#### Noise Level Standards

The 1965 NAB Standards state that for full track reel-to-reel recorders such as the RCA RT-21B, at 15 or  $7\frac{1}{2}$  ips, the noise should be 50 dB below NAB

\* The distortion here was due to the tape itself, the record amplifier having negligible distortion.

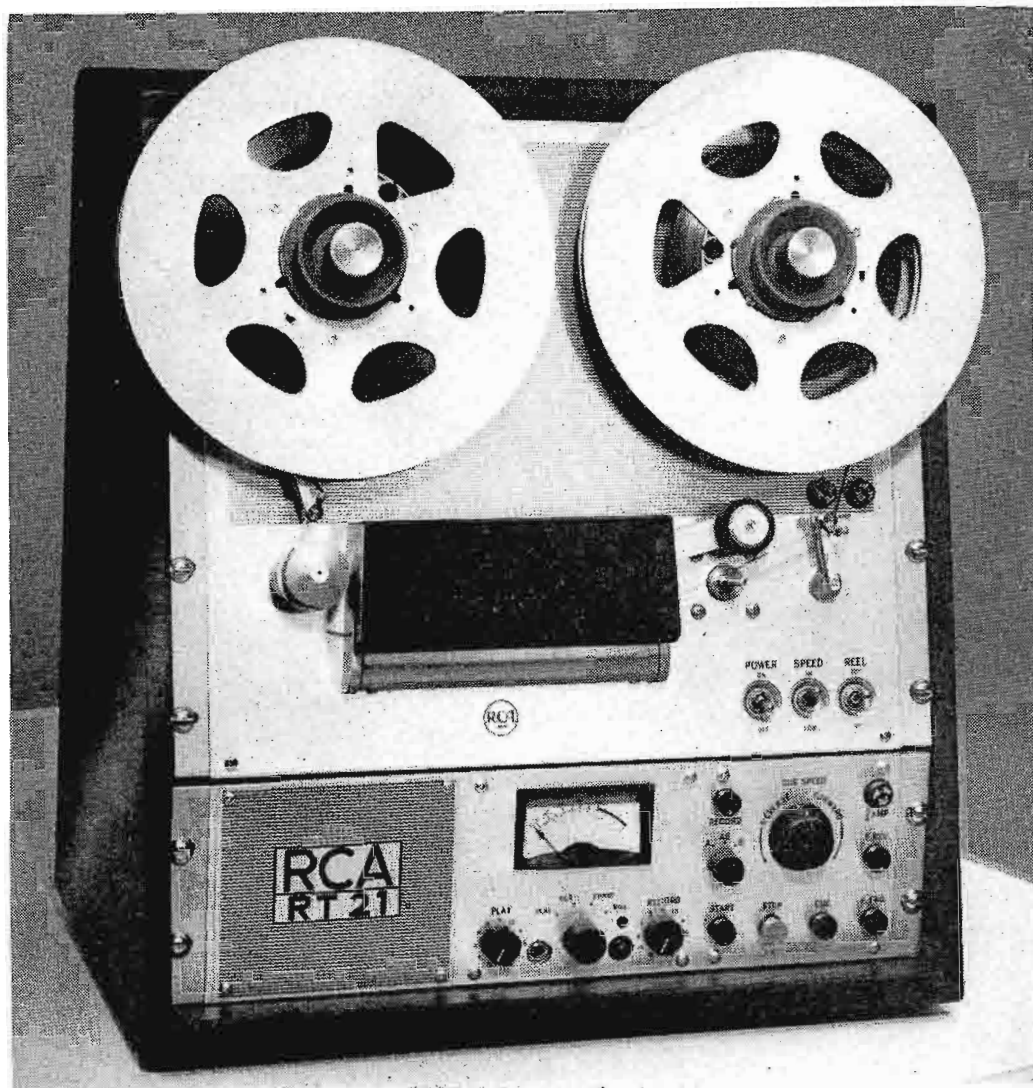
Level. This compares to a S/N ratio of 56 to 58 dB in terms of the old standard, since the 3% THD level must be at least 6 dB (usually 8 dB) above NAB Level. Though the new standard requires only 50 dB S/N ratio compared to the old standard of 55 dB, it is actually 1 to 3 dB tighter because of a change in the meaning of the word signal.

For two-track reel machines, and monaural cartridge machines, such as the RT-17A, noise should be 45 dB below NAB Level. This new S/N ratio corresponds to a S/N ratio of 51 to 53 dB referred to the old standard. These machines lose about 5 dB because of the narrower track width. Stereo cartridge machines lose an additional 3 dB because of a still narrower width of only .043 inches.

#### "NAB Level" Tapes

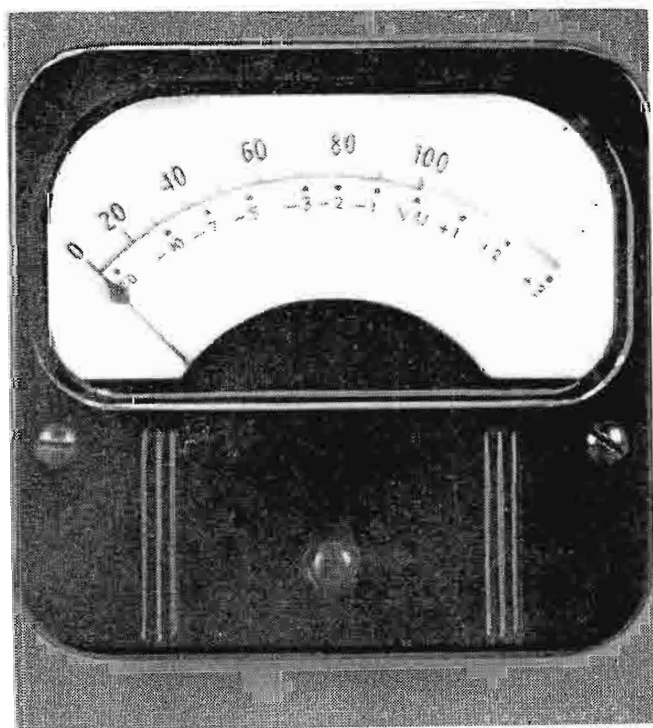
Actually, the only source of NAB Level is from an official test tape issued by NAB. If such tape is not available, it is possible to produce an approximate "NAB Level" that is accurate within one or two dB, for use until an official tape is on hand. This is done by recording a 400 Hz tone on a machine that is in

**FIG. 3.** The RCA RT-21B Reel-to-Reel Tape Recorder is available in this desk top mounting or for use in a cabinet rack or mobile console as shown in Fig. 2. Designed to meet and exceed the rigid performance specifications for monaural and stereo broadcast service, the RT-21B features solid state circuitry and plug-in modular construction for long life and easy maintenance, continuously variable cue speed control for safe, rapid location of material on recorded tape, and complete remote control provisions.



excellent condition at a level that produces three per cent THD, and then backing off the record input 8 or 9 dB so that the playback level drops exactly 8 dB\*. In other words, record 400 Hz 8 dB down from the 3 per cent THD

\* The tape has some compression at these levels, so to achieve a drop of 8 dB on playback, the record signal must be reduced a little more than 8 dB.



**FIG. 4.** Standard VU meter with percentage scale (top) and VU scale below.

level. A general purpose tape such as the RCA 15A or 15M should be used for this. Bias should be adjusted for maximum 400 Hz output, for a low level recording.

#### Record VU Meter Calibration

The intent of the NAB standards is that programs be recorded at NAB level. This means that the record VU meter should read 0 VU (100%) when recording at NAB level. RCA cartridge machines have an internal calibration control to make this adjustment. The RCA RT-21B reel-to-reel recorder, on the other hand, has a fixed calibration. This calibration averages a dB or so high with full track machines, and the same amount low for half track machines. This arrangement is satisfactory from a practical standpoint, since it is as close as a VU meter can read program levels in regular operation.

#### Tape Noise

All the *audible* noise in professional tape recorders such as the RT-21B is caused by the tape, and sounds like a hiss. Since the hiss is on the tape, obviously no matter how much better the playback amplifier is made, the audible hiss stays the same. Only a better tape will reduce the hiss. Recently, quieter tapes such as the RCA 15-ALN have been announced, and they do provide about 5 dB reduction in hiss. However, the

measured S/N of these tapes may not show a 5 dB improvement for reasons discussed in the following.

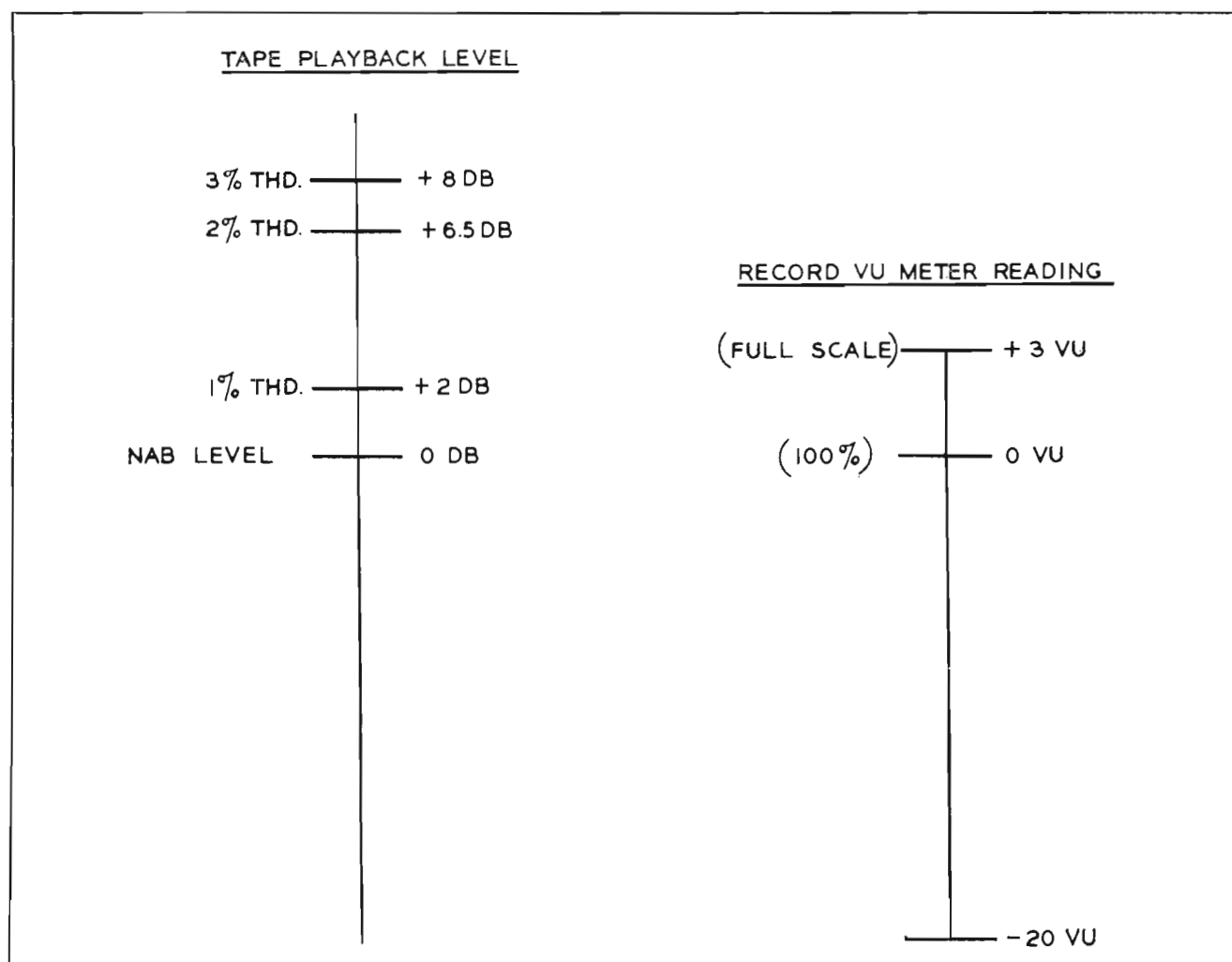
#### The Ear vs the VTVM

The ordinary VTVM with its flat response measures all noise components in the audio range. However, the response of the ear is very different from the VTVM. The ear is more sensitive to hiss than it is to low level hum. On the other hand, the VTVM reads the strongest components, which are hum and low frequency noise. A full track RT-21B tape recorder, for example, has remarkably good audible S/N ratio. When the head cover is removed, the ear detects almost no increase in noise. Yet the measured S/N will show a hum increase of 6 dB!

#### NAB Weighted Noise Measurement

The 1965 NAB Standard recognizes the differences between ear and meter response. It calls for two measurements: an ordinary noise measurement, which checks all types of noise — hum, hiss, etc., plus a weighted S/N measurement that gives the VTVM a response similar to that of the ear. The latter is achieved with a simple filter. The Standard then specifies a weighted S/N that can be met only by machines whose amplifiers contribute negligible hiss compared to that of the tape itself.

**FIG. 5.** Diagram showing location of new NAB Level in a range of total harmonic distortion (THD) and tape playback levels. Levels of VU meter scale are shown at right for comparison.



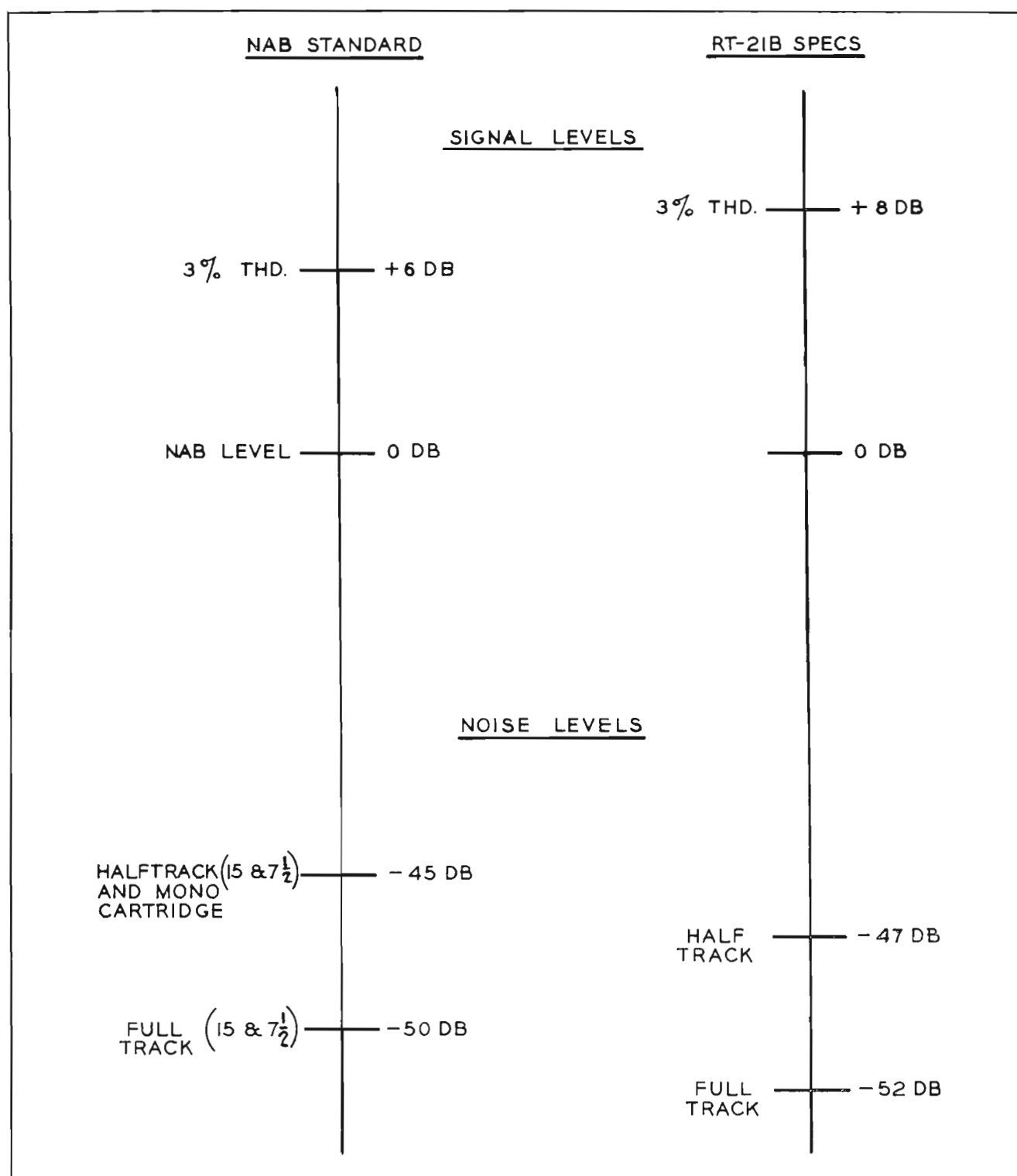
A weighted noise specification is a guarantee that a machine is giving the lowest possible hiss that can be achieved with ordinary tape. Note that the weighted noise measurement supplements the ordinary S/N measurement. It does not replace it.

**Conclusion**

The 1965 NAB Standard is a welcome guidepost to audio tape recording. The Standard is unique in two ways: First, it selects a record signal level that is identical to the program level; second, it adds a weighted S/N measurement that corresponds to what the listener hears. In addition, the Standard makes it possible to chart limits over a wide range of levels when comparing various types of machines (See Fig. 6).

Certainly the 1965 NAB Standard should dispel the confusion that has existed in the industry by providing not only a realistic solution to S/N measurement, but also, a yardstick by which to measure the performance of genuinely professional machines.

**FIG. 6.** Diagram showing new NAB Standards for signal and noise (left). Right half of diagram shows performance specifications of RCA Type RT-21B Reel-to-Reel Tape Recorder, which substantially exceed NAB Standards.



# BCA-15 AUTOMATIC AUDIO TAPE PROGRAMMER

Solid State Logic and Relay Switching Combined In  
One Compact System to Automate Equipment Operation

If one pair of hands is not enough to get you through each station break; if expensive errors keep cropping up; or if you'd just like to tighten the sequence so you can add to your programming . . . we suggest something really new in audio tape automation—this RCA BCA-15 Audio Tape Programmer. Here is a reliable and economical device which may be used in a variety of applications. Read about it in this authoritative article.

by R. H. BARNABY, *Manager*  
and

R. C. ROGERS,  
*Broadcast Audio Product Merchandising*

The new RCA Audio Tape Programmer, BCA-15 is illustrated in Fig. 1. It is designed to select from as many as 18 audio sources, and sequence them automatically in any preset pattern as 15 consecutive program events.

While intended primarily for use with RCA Type RT-8, RT-17, RT-37 and RT-22 cartridge and reel tape recorders,

the BCA-15 may also be used with TV film projectors, video tape recorders or in live program sequences. In fact, *any* program source may be used if it can be started by a contact closure and also provides a contact closure to signal the end of the material. End of material closure may also be provided by a clock. The BCA-15 makes it possible for a very

minimum of station personnel to program multi-event sequences. Enclosed relays and solid state logic circuits provide reliable, high speed switching with so little noise that operation of the BCA-15 is even practical in open mike areas.

## Typical Monaural and Stereo Systems

The BCA-15 is particularly advantageous to stations requiring separate programming for AM and FM. The operator who may be handling both programs, for example, can preset the BCA-15 to automatically sequence the FM events during times when live broadcasts or program changes must be made on AM.

Figure 2 illustrates types of program sources that can be used with the BCA-15 in monaural or stereo systems. An AM broadcaster might use the equipment setup consisting of the RCA monaural RT-22 reel-to-reel recorder, the RT-17 cartridge tape player and the monaural version of the RT-8 multi-cartridge playback system.

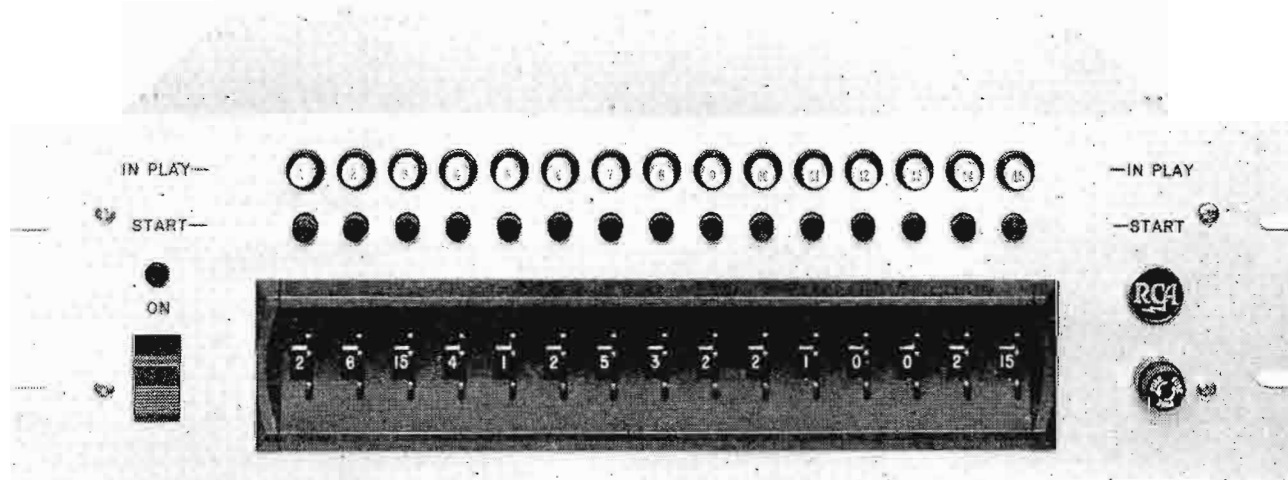
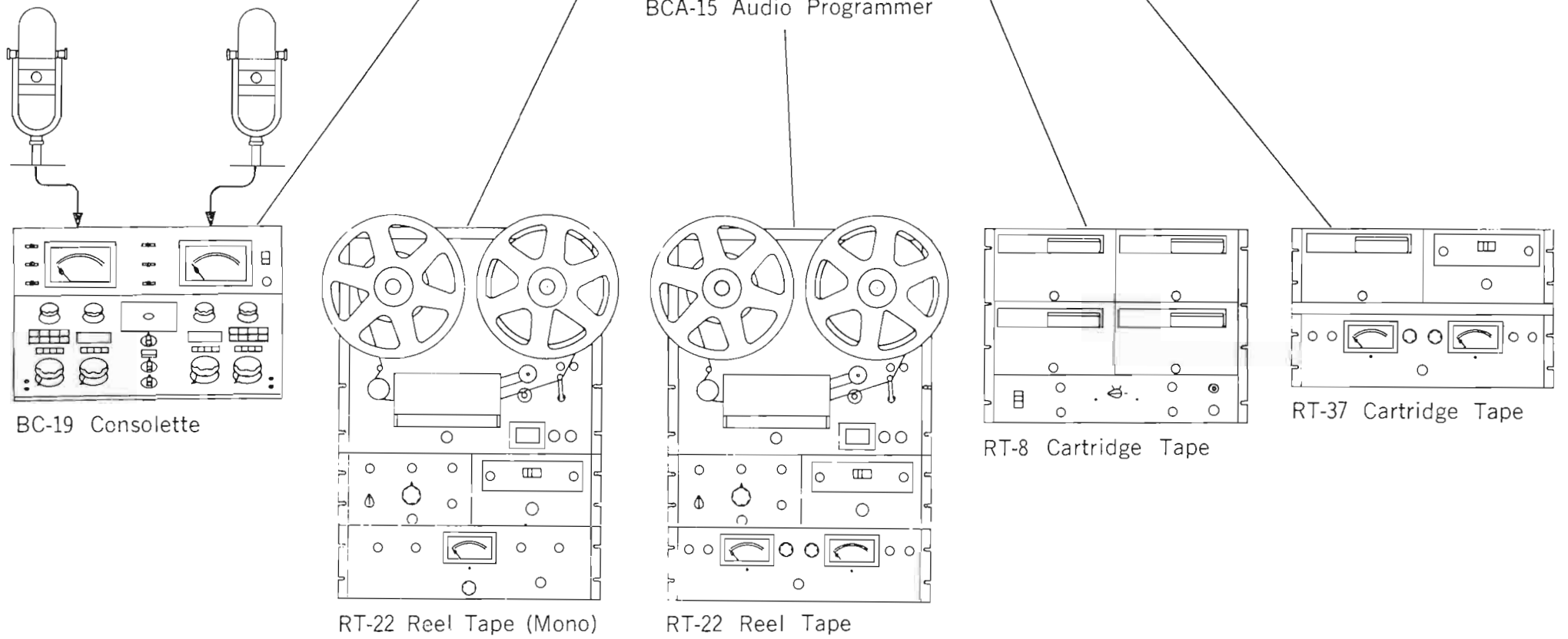
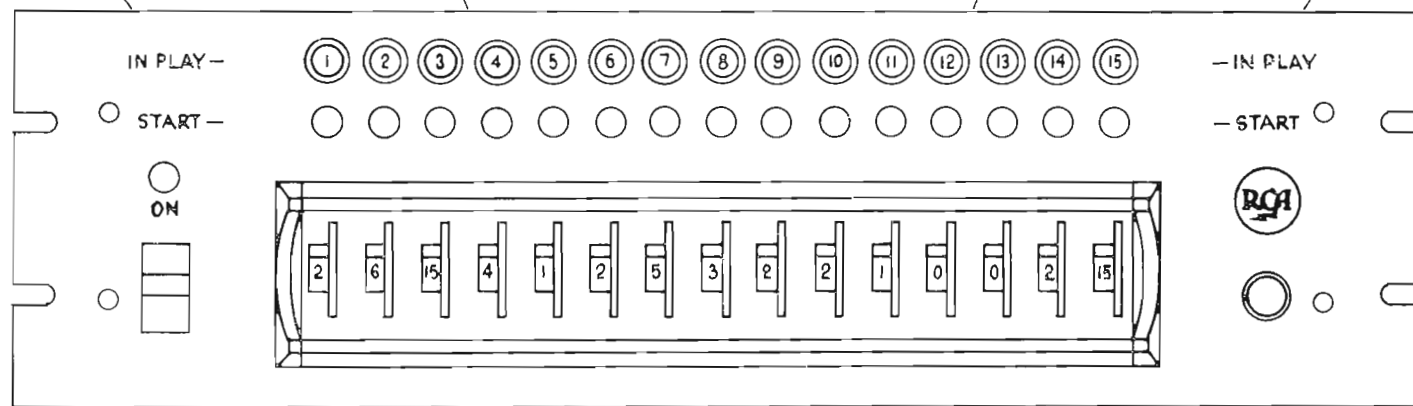
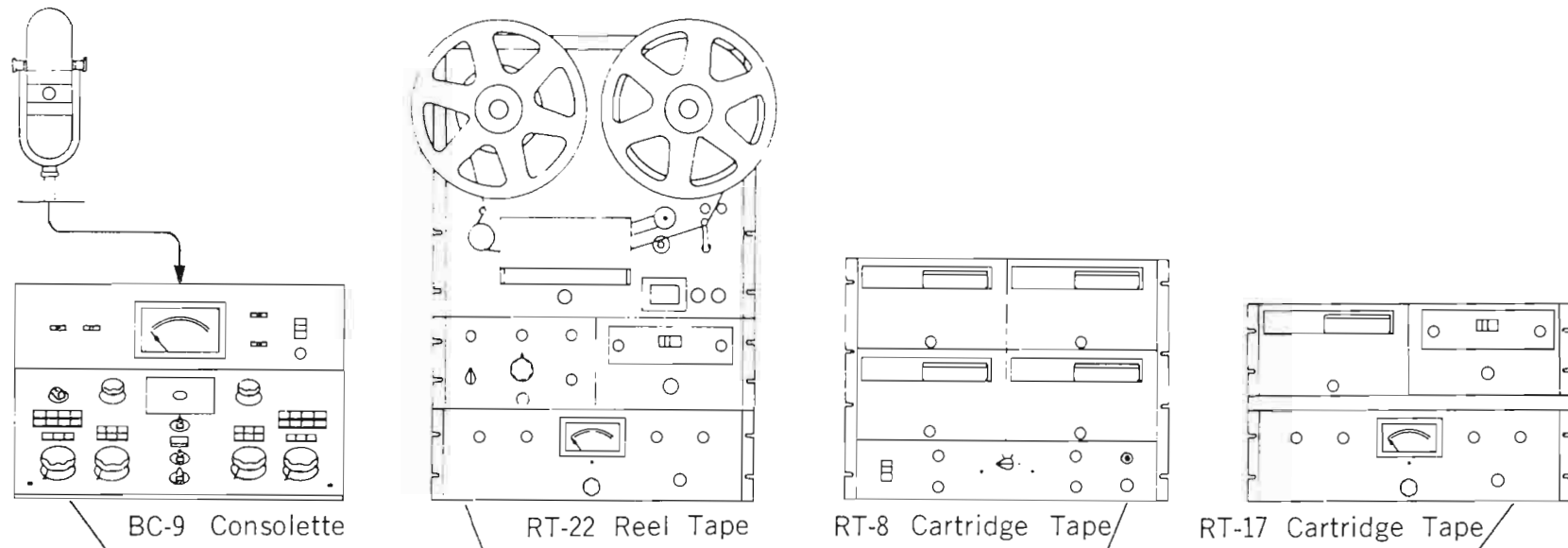


FIG. 1. BCA-15 Automatic Tape Programmer.



## MONAURAL SYSTEM



## STEREO SYSTEM

FIG. 2. Typical BCA-15 automatic programming setup for either monaural or stereo operations.

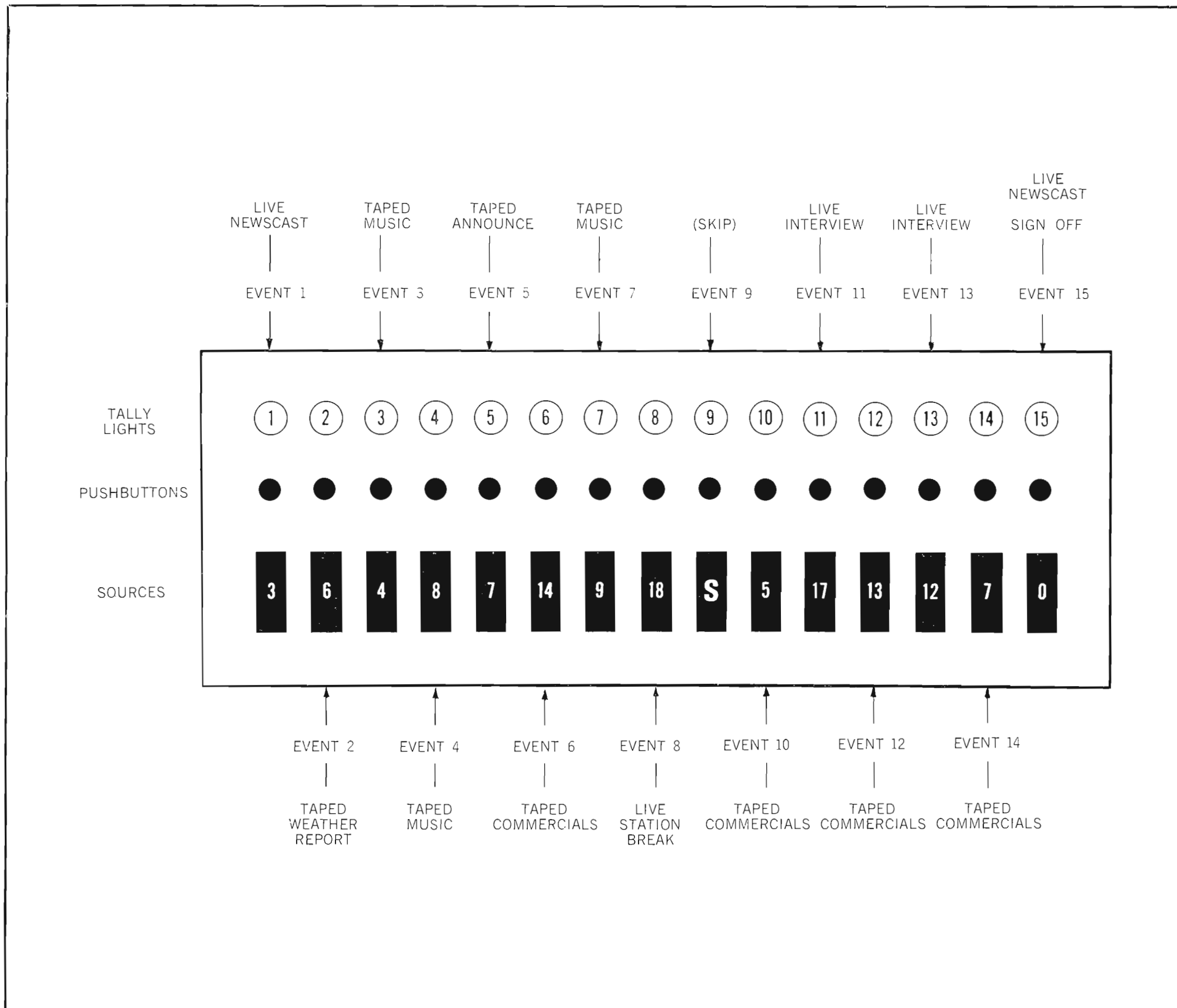


FIG. 3. Typical 15-event preset program.

An FM operation, on the other hand, might require the stereo versions of the RCA RT-8 and RT-22 reel recorders, plus the RT-37 which is the stereo counterpart of the RT-17 cartridge playback equipment. If monaural commercials are to be used in stereo operations and are to be aired simultaneously on the two stereo channels, the economical tape playback equipments for these commercials could be the RCA Type RT-17 or the monaural models of the RT-8 and RT-22 equipments.

#### Fully Automatic Sequencing

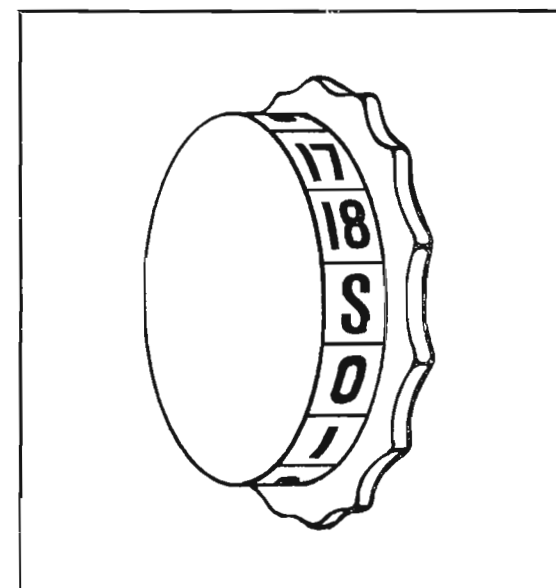
After being preset and started the BCA-15 will continue to program auto-

matically up to the full set of 15 events or multiples without attention or error. If changes are necessary during programming, events can be easily substituted or skipped, or the program sequence can be stopped at any time.

Each of the 15 events is programmed by means of a thumbwheel switch which selects any of the 18 program sources. Control is given in sequence by circuits in the unit, the end of one event initiating the beginning of the next.

A typical setting of the BCA-15 event switches for a period of automatic programming is shown in Fig. 3. All start and stop connections have been made between

FIG. 4. Thumbwheel switch program selector.



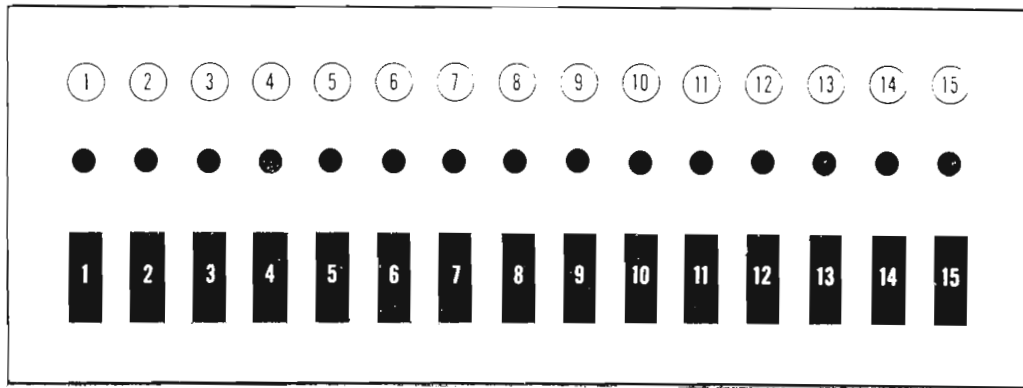


FIG. 5. Event switches set for random selection of 15 program sources.

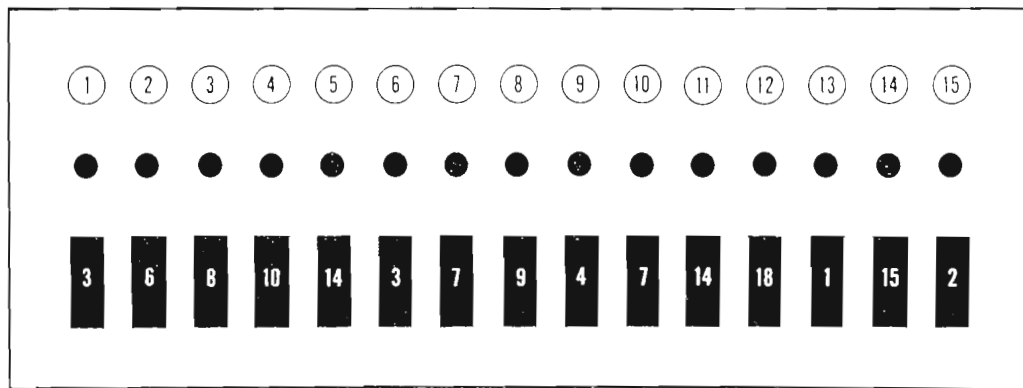


FIG. 6. Event switches set for preselected order of 15 program sources.

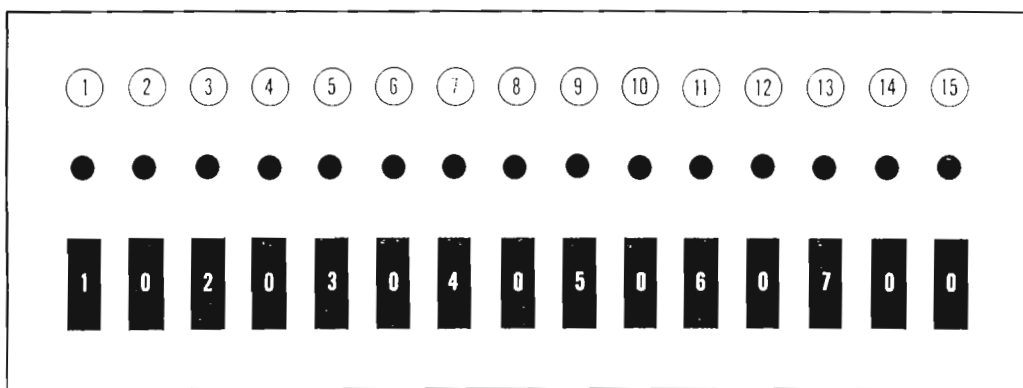


FIG. 7. Alternate event switches set to "O" to provide stops.

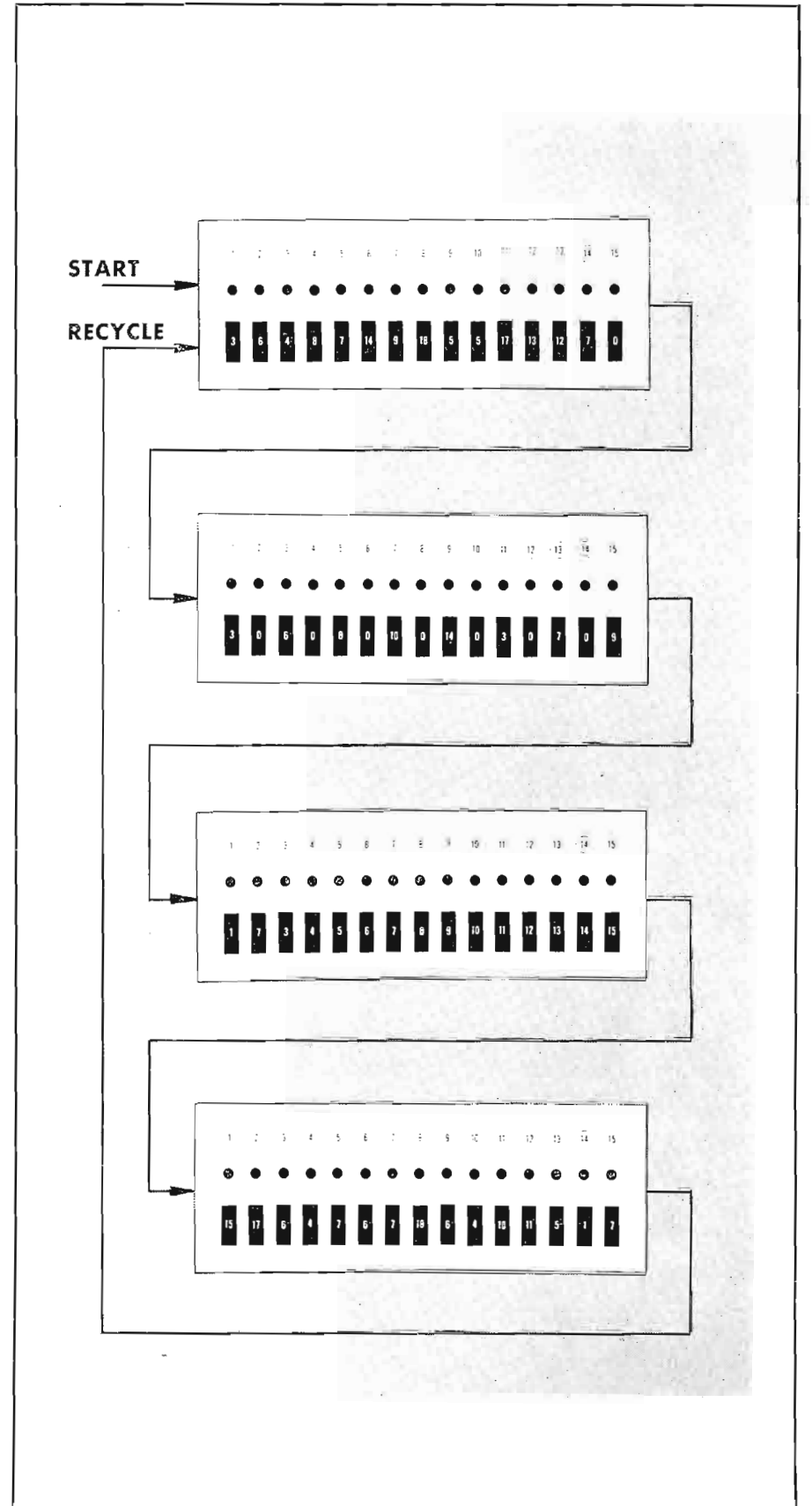


FIG. 8. Four BCA-15 units cascaded to provide a 60-event system.

the unit and the program sources to be controlled, so that when the front panel START button is pressed, the programmer will begin with the newscast (source 3) preset as Event 1. After completion of Event 1, Event 2, the taped weather report (Source 6) will be played, and so on, through all the preset events until Event 15 is reached, whereupon the BCA-15 will either repeat or terminate the programming sequence. The programming sequence is terminated in this particular example because the Event 15 switch is set in the "O" or off position. If this switch had been set to select a program source instead, the sequence would have recycled to Event 1 and continued to repeat. Note also that

Event 9 switch is set to "S" or the skip position. Thus, after Event 8 (Source 18) has finished, Event 9 will be skipped and Event 10 will be played instead. The operator may do this either to cancel a selection at the last minute or to provide a slot in the program sequence for another program source to be inserted later. Tally lights above the switches show which event is being played.

#### Manual Control Options

Automatic features of the BCA-15 can always be waived and the unit used as a start panel for 18 program sources. In this mode the stop or "end of program" interconnections that normally start the next

program source are not made, the starting being done by pressing the pushbuttons above the source to be started.

Two methods of manual operation using the pushbutton switches are available, depending upon the settings of the thumbwheel switches. When the switches are set as in Fig. 5, program sources may be selected at random by pressing the pushbutton associated with any one of the 15 program sources. When the switches are set in Fig. 6, a preselected order for program sources is selected by operating the pushbuttons in sequence from left to right. If stop connections have already been made to the unit and this mode of operation is desired, it is only necessary to set

alternate thumbwheels to the "O" or off position as shown in Fig. 7. However, this will reduce the number of available sources or events from 15 to 7.

### Expandability

The number of program events sequenced or program sources utilized can be expanded almost without limit by using BCA-15 units in cascade. Two programmers, for example, permit the operator to use up to 36 program sources, and sequence as many as 30 events. Fig. 8 illustrates four units in cascade to produce a system capable of 60 events.

In addition, each BCA-15 may itself be made a program source. This extends the number of events by adding a "sub program" of events as shown in Fig. 9. Finally, each of the four BCA-15 may have different program sources, adding up to a total of 72. Any of these systems, or their combinations are certain to fill most program requirements.

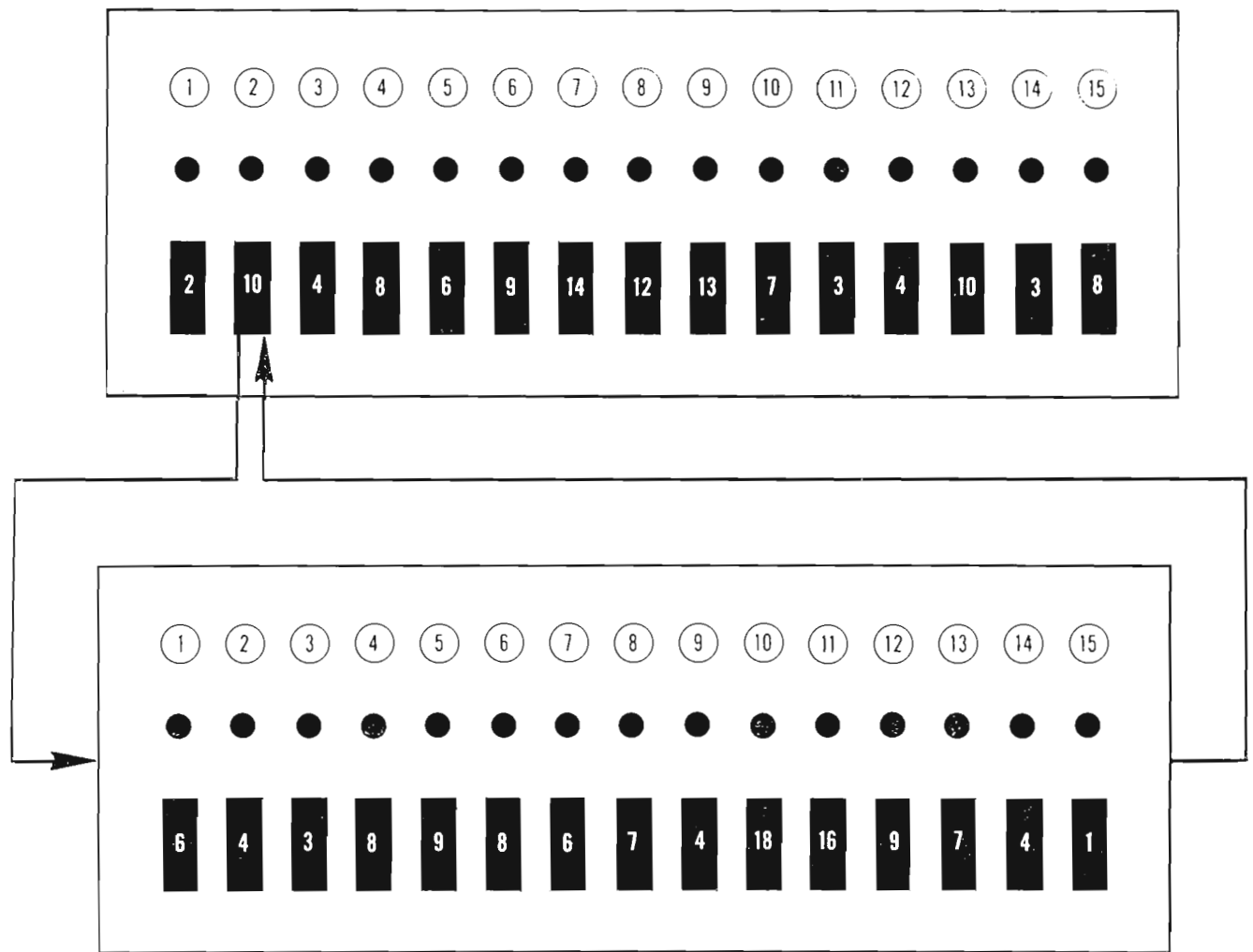
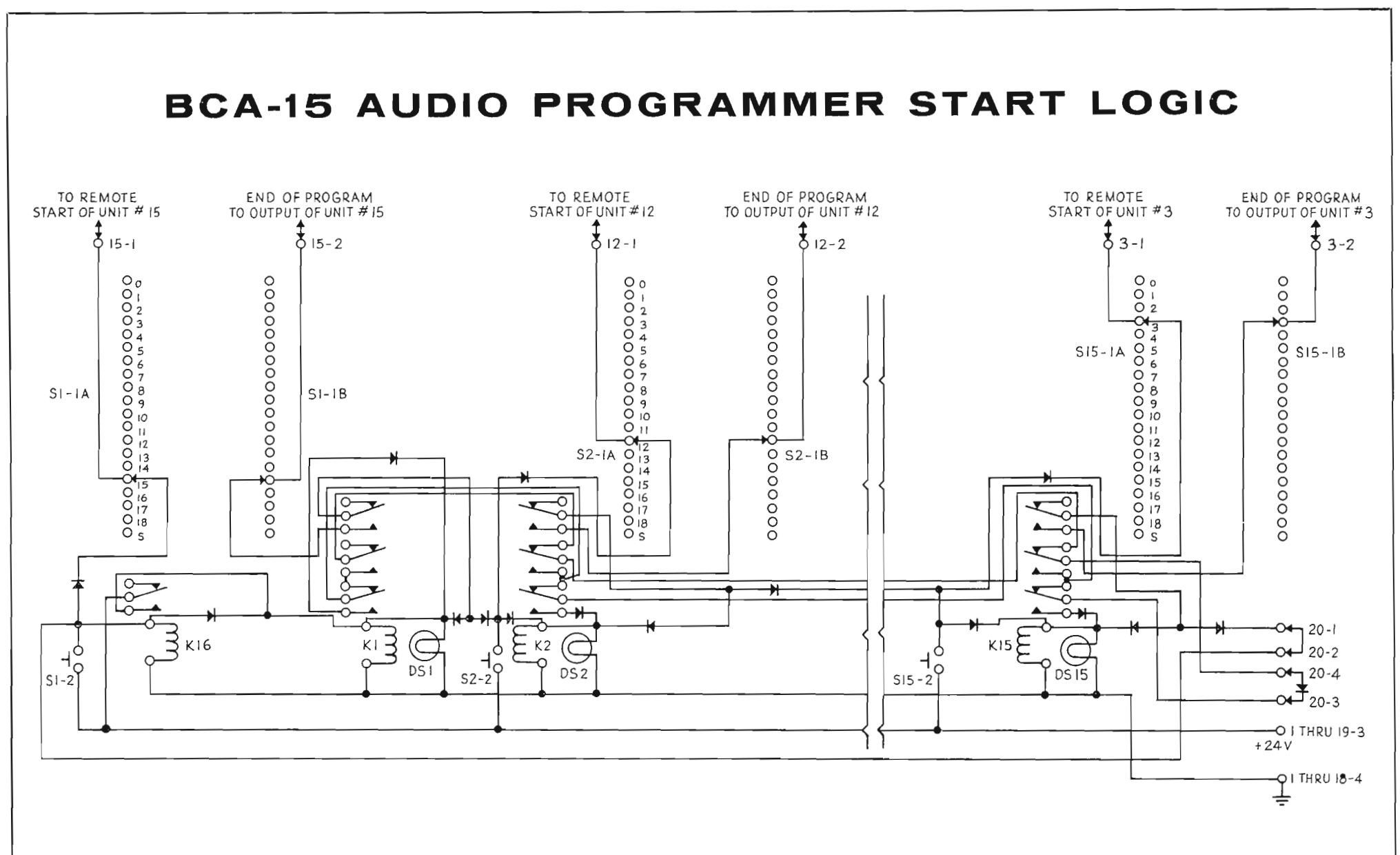


FIG. 9. Additional BCA-15 unit used as "sub program." Capacity 15 events, 32 sources.

FIG. 10. Simplified functional diagram illustrating basic sequencing operation of BCA-15.



### Solid State Logic Circuits

The basic sequence control circuitry of the BCA-15 is all solid state and utilizes silicon diodes in a logic matrix. Relays are used instead of stepping switches resulting not only in instantaneous operation but also in quieter performance.

Fig. 10 is a simplified functional diagram of the BCA-15 control circuit. To illustrate operation, assume the sequence begins by pressing START switch S1 associated with Event 1. Closure of S1 energizes relay K1 and simultaneously sends a start pulse to program source 15 which has been previously selected as Event 1. Voltage is supplied to lamp DS1 indicating Event 1 is in play. Relay K1 connects the output or stop side of Event Switch 1 to the start side of Event Switch 2. When the end-of-program pulse is received from program source 15, it will operate relay K2. This in turn lights indicator lamp DS2 and sends a start pulse to program source 12, which has been preset as Event 2. Operation of relay K2 causes relay K1 to open stopping program source 15 and at the same time connects the stop side of Event 2 to the start side of switch 3. The sequence will continue through Event 15 then recycle to Event 1 and so on, until a stop is indicated.

### Compact Mounting Space

The BCA-15 is designed for mounting in a standard 19-inch equipment rack such as the RCA BR-84. Only 5¼ inches of vertical panel space is required. The unit is styled to complement other RCA equipment, the front panel attractively finished in tough aluminum epoxy paint. Relays are miniature, totally enclosed plug-in types readily accessible from the rear. As seen in Fig. 11, barrier terminal strips are employed to connect program source start and stop signals; a six foot cord attached to the unit supplies power. All components selected are of uniformly high quality for maximum reliability. The rugged chassis and frame is designed to withstand the rigors of studio operation. Total weight of the BCA-15 is 16 pounds.

### Conclusion

The BCA-15 is a new general purpose tool which the broadcaster will find particularly valuable in extending the use of reel to reel and cartridge tape systems. Only very few of the many important uses for this unit have been presented here. Doubtless, there will be many more applications with the continued growth of tape and station programming automation.

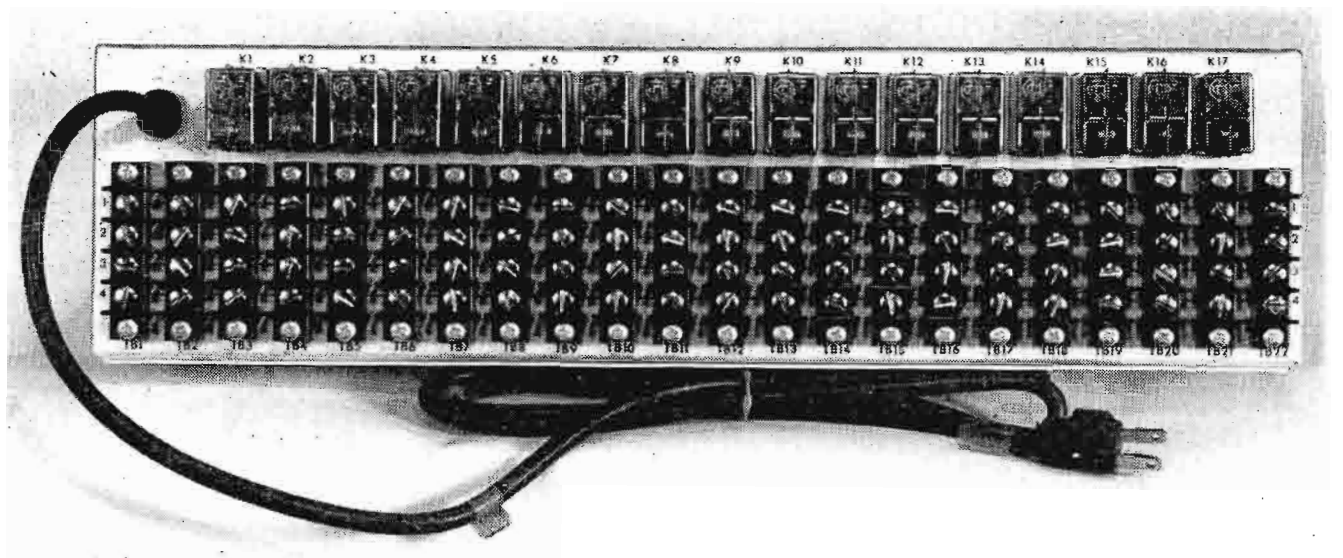
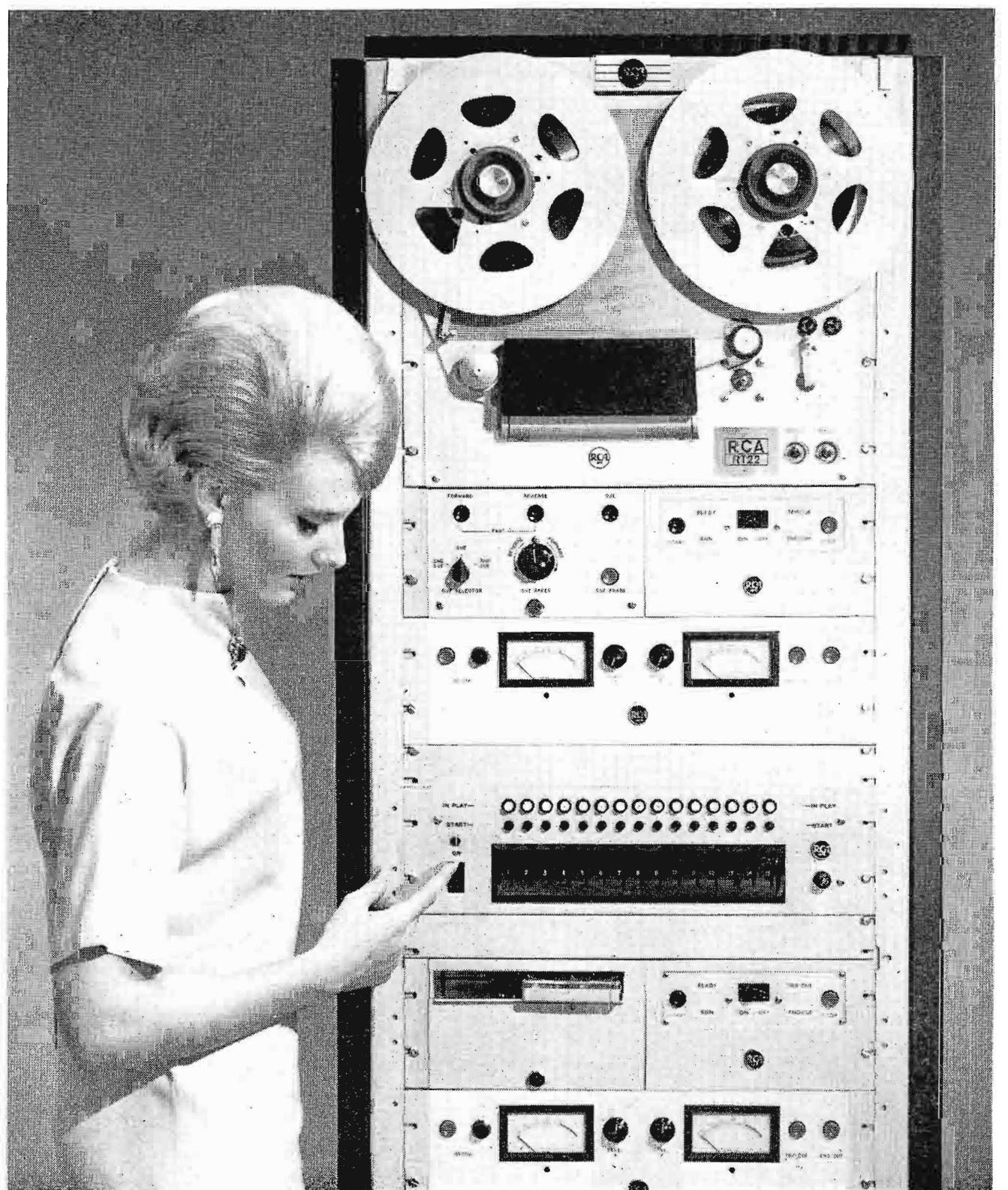


FIG. 11. Rear view of BCA-15 showing switching and program line interconnection terminals.

FIG. 12. BCA-15 shown with RT-22 reel recorder (top) and RT-8 cartridge recorder (bottom).



# SUPER POWER FM TRANSMITTER ADDED TO RCA FULL FIDELITY FM LINE

New 40 kilowatt BTF-40E Diplexes Two Proven Transmitters  
to Give Added Advantage of A Standby

by H. W. WESSENBERG and W. D. WENGER

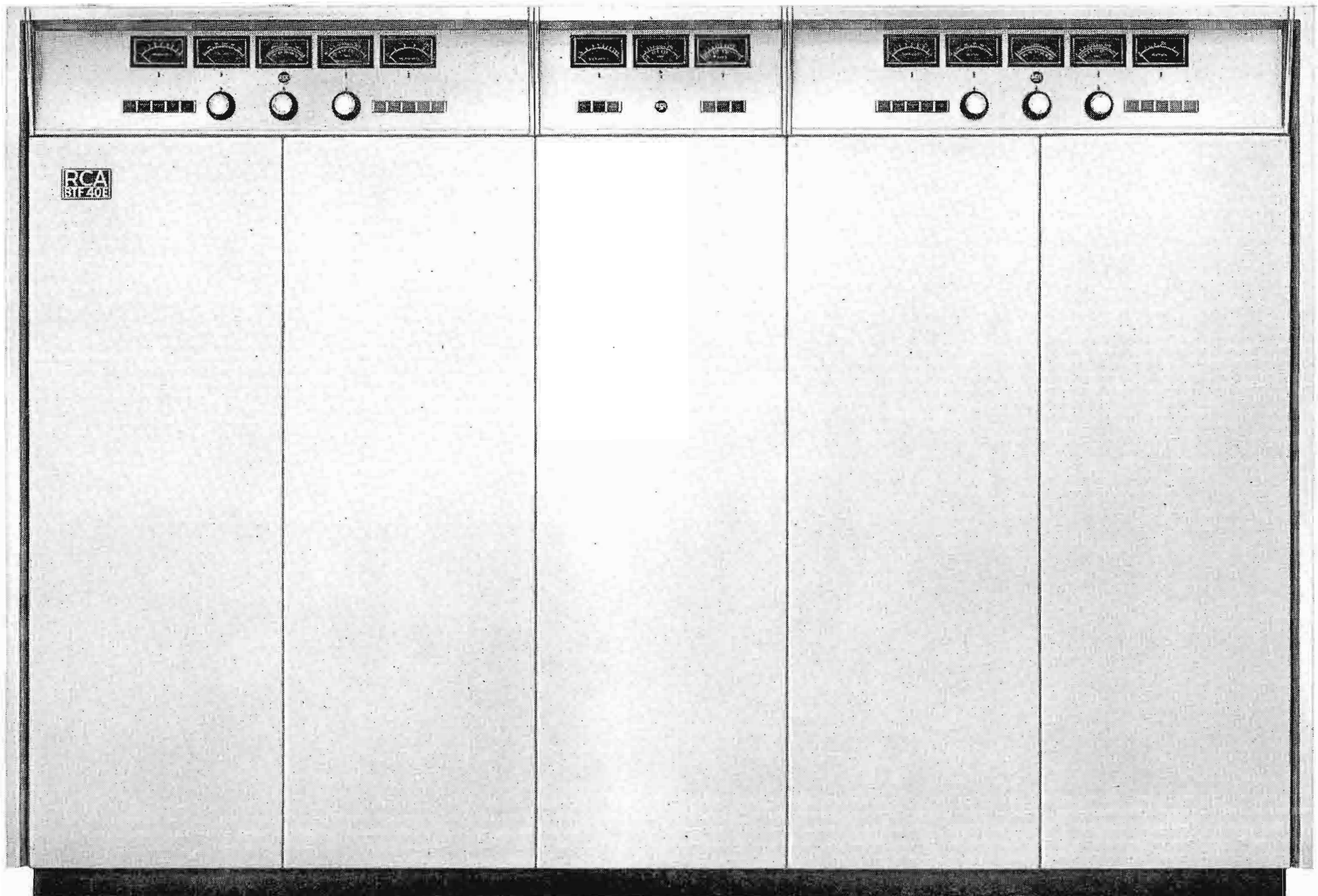
*FM Transmitter Merchandising*

This new transmitter is just the answer for FM broadcasters who are thinking remote control or very high power. It is ideal for those with dual polarized or circular antenna systems who wish to maintain their maximum permissible ERP. Reliability of the new transmitter is unsurpassed for unattended operation. The BTF-40E is in production and the first unit is in operation at WMC, Memphis, Tennessee.

Economical high power for increased range or for the popular dual and circularly polarized FM antennas is now a reality with the new BTF-40E. Actually exceeding a full 40 kW output on all FM channels, the new transmitter doubles the upper power limit of RCA's present FM line which includes 1 kW, 5 kW, 10 kW and 20 kW models. All RCA FM transmitters including the new 40 kilowatt unit are fully air cooled, and all are housed in beautiful space blue New Look cabinets.

The BTF-40E consists of two RCA 20 kW units diplexed into a single transmission line and driven by one of the two operating exciters. The 20 kW cabinets are arranged on either side of a "combiner" cabinet which contains the control panels and diplexing equipment. RCA 20 kW transmitters have been used successfully by many stations over a period of time with only minor outages and excellent tube life. Thus, the 40 kilowatt output power is achieved with tried and proved components.

FIG. 1. Type BTF-40E FM transmitter offers unexcelled reliability by combining the outputs of two 20 kW units. Combining equipment is housed in center cabinet.



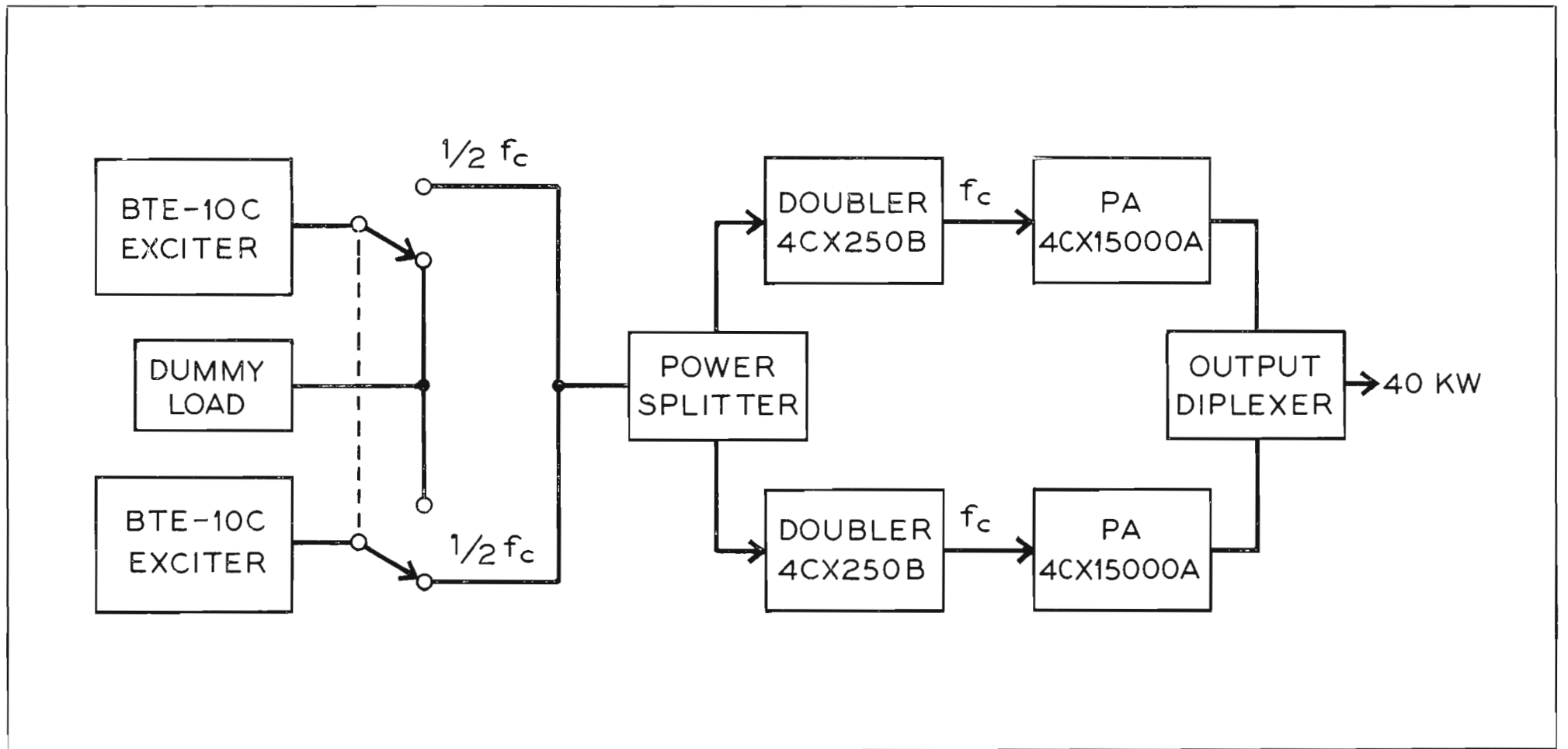


FIG. 2. Block diagram of 40 kW transmitter showing power splitter, output combiner (diplexer), and switch for selecting either of two operating exciters.

Owners of RCA BTF-20E transmitters can, with slight modifications, double power economically by adding another BTF-20E and combiner to their present installation. Those going to circular antenna polarization as provided by the RCA Type BFC antenna (or to combinations of horizontal and vertical radiators) where only half the transmitted power is radiated horizontally, can double their transmitter power without exceeding their licensed horizontal ERP since the additional power radiated is in other planes of polarization.

**"Hot Standby" Reliability**

The BTF-40E power amplifier diplexes the outputs of two 20 kilowatt, Class C 4CX15000A ceramic tetrodes into a coaxial line combiner that feeds through the harmonic filter to the antenna. Diplexing, which is more efficient than just paralleling two tubes, achieves the ultimate in reliability and attention free operation that is obtained from all redundant circuitry. It is like having a standby transmitter warm and ready for instantaneous switchover if trouble develops in the main transmitter. Should either BTF-40E amplifier fail, the other continues to operate unaffected, supplying reduced power to the antenna. A relay system permits switching to the hot standby exciter if the main exciter fails. Since power supplies and controls are separate and duplicated, the individual circuits of either transmitter may be shut down and worked on while the other transmitter is in operation.

FIG. 3. Type BTF-20E FM transmitter. One of the two 20 kW units that make up the 40 kilowatt BTF-40E.



These features assure a minimum of lost air time, even for the unattended transmitter, whether through unit failure or through their removal from service for repair or maintenance. Solid state rectifier power supplies and separate grid bias supplies also with semiconductor rectifiers are used for their long life and because they increase transmitter stability. No tube or selenium rectifiers are used. High voltage diodes used are silicon and rated for 20 amperes, 400 volts PIV. Circuit breakers instead of fuses further add to dependability particularly when operating remote control.

### Built for Remote Control

The special reliability features of the BTF-40E are particularly important to the increasing number of stations contemplating remote control or unattended operation. Exciter switching and the dual amplifiers provide a transmitter of unmatched dependability. Circuits are simplified to eliminate unnecessary components and thus utilize fewest controls.

Remote control provisions in the transmitter include terminals for connection of the RCA BTR-20C Remote Control Unit. Terminals are provided for remote control of transmitter on/off, plate on/off, raise/lower power, and overload reset, plus remote metering connections for final amplifier plate current, plate voltage and power output. Sufficient controls are available on the BTR-20C remoting system to control the transmitter as either a 40 kilowatt unit or as individual 20 kW transmitters. The BTG Series Automatic Logging equipment can also be added.

### Output Patching

The diplexer used with the BTF-40E transmitter is an efficient coaxial line bridging device that permits feeding both transmitters into a common line without significant energy being fed from one transmitter into the other.

Failure of either transmitter results in a 6 dB reduction in power fed to the antenna, with one-fourth of the power from the operating transmitter going into an air cooled load. To provide for feeding this power to the antenna instead of into the load, a coaxial output patching system can be set up and either manually or electrically controlled to switch the output of the operating transmitter directly into the harmonic filter, bypassing the diplexer and associated load. This results in one-half rather than one-fourth the original power being fed to the antenna if a transmitter fails. This coaxial patch system can be arranged as shown in Fig. 5 to also switch either transmitter or the output of the diplexer into a dummy load when desired for tests, measurements or other purposes.

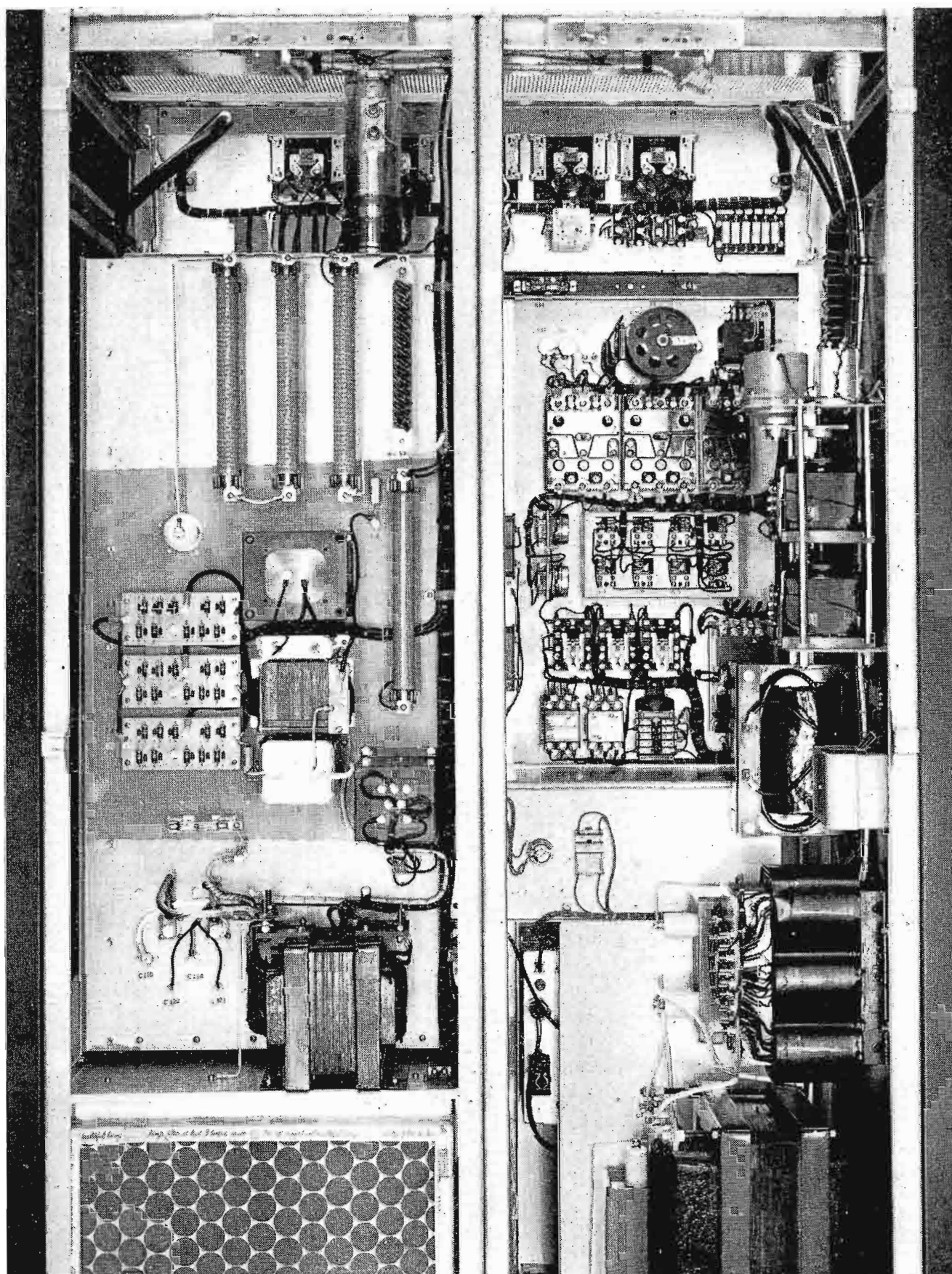


FIG. 4. Rear view of one section of the BTF-40E showing vertical construction of PA cavity at left and control panel to right.

## FEATURES OF THE RCA FULL FIDELITY FM LINE

### Compact Installation

The exceptionally small space requirements of the FM line are shown by the floor plan diagrams which suggest possible layouts for the 5, 10, 20 and 40 kW transmitter, harmonic filter and power supply. The BTF-1E is completely self contained and therefore requires no external power supply. The 77-inch high cabinet is only 27 inches wide and 20½ inches deep. The harmonic filter, which is supplied as standard equipment with each transmitter, is mounted overhead. It is a reflective type filter—not merely a second harmonic trap. No energy is absorbed and harmonics are guaranteed to be down

at least 80 dB. The separate unitized power supply in each case consists of power transformer and silicon rectifiers, and can be installed remote from the transmitter in a basement, attic or other convenient place.

In laying out a transmitter room it may be wise to allow room for some future expansion. The floor plan diagrams permit an approximation of the space needed for each transmitter room. Expansion from a five to a 20 kW transmitter increases the occupied floor area by less than one square foot. Expansion of a 20 kW transmitter to 40 kW requires about 42 square feet of additional occupied space.



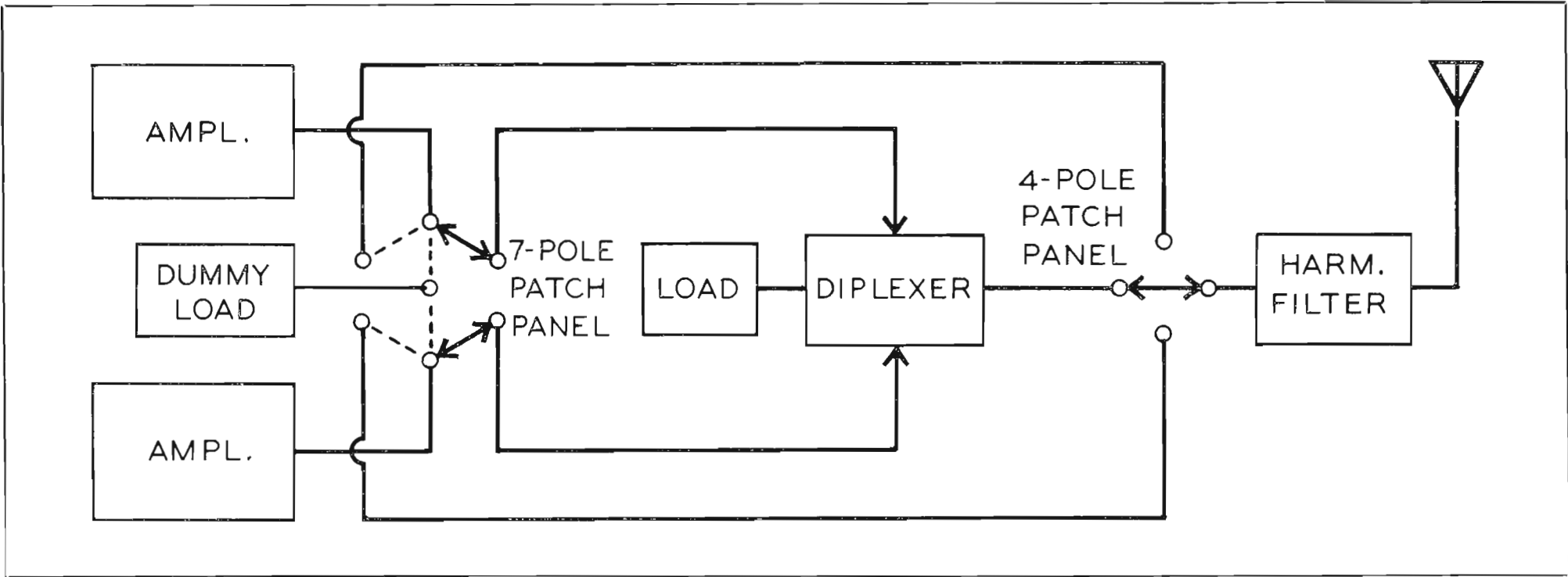
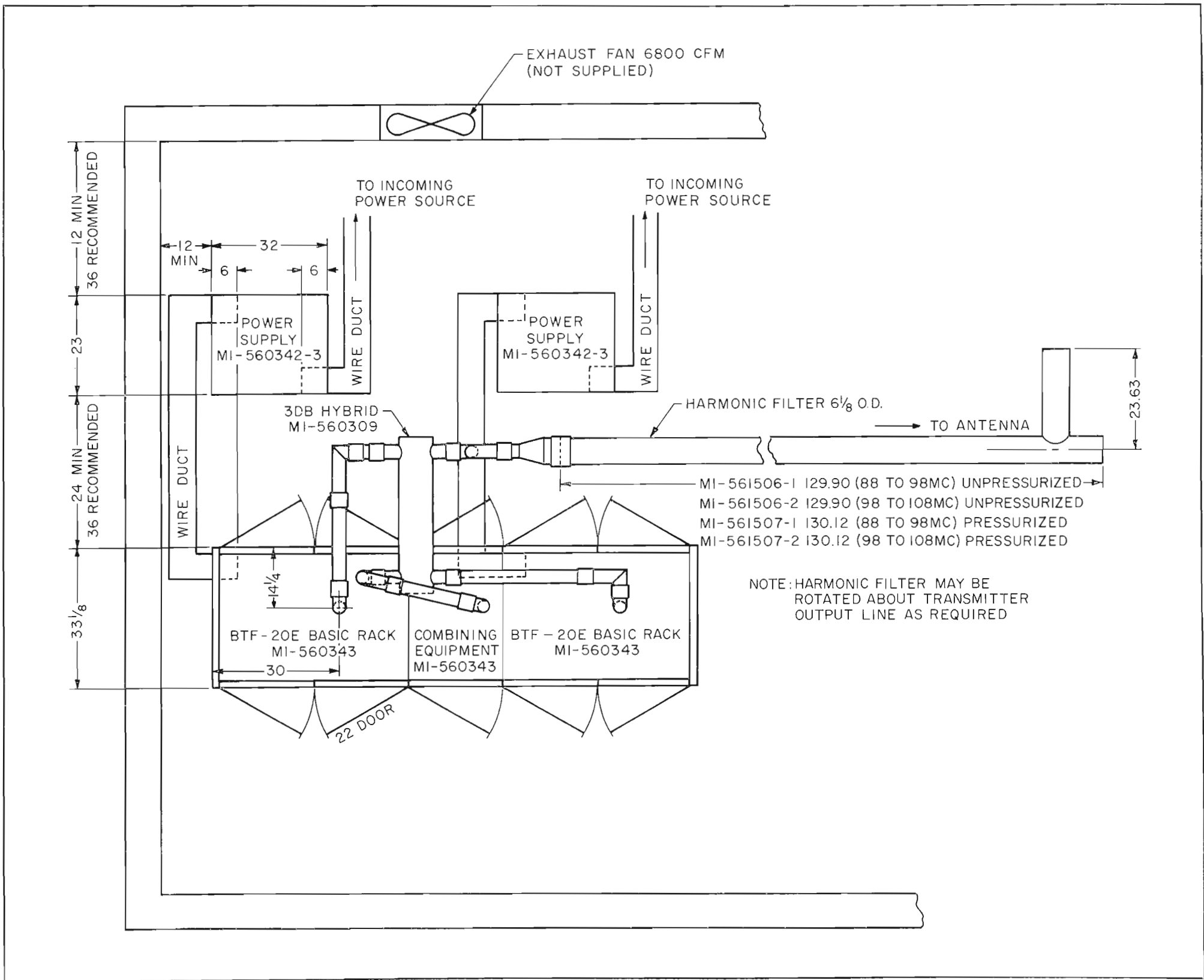


FIG. 5. Schematic diagram of suggested patch panels to provide for switching either amplifier directly to the harmonic filter to bypass the diplexer, or to the dummy load for test or measurement purposes.

FIG. 6. Floor plan arrangement of BTF-40E transmitter, harmonic filter and power supplies.



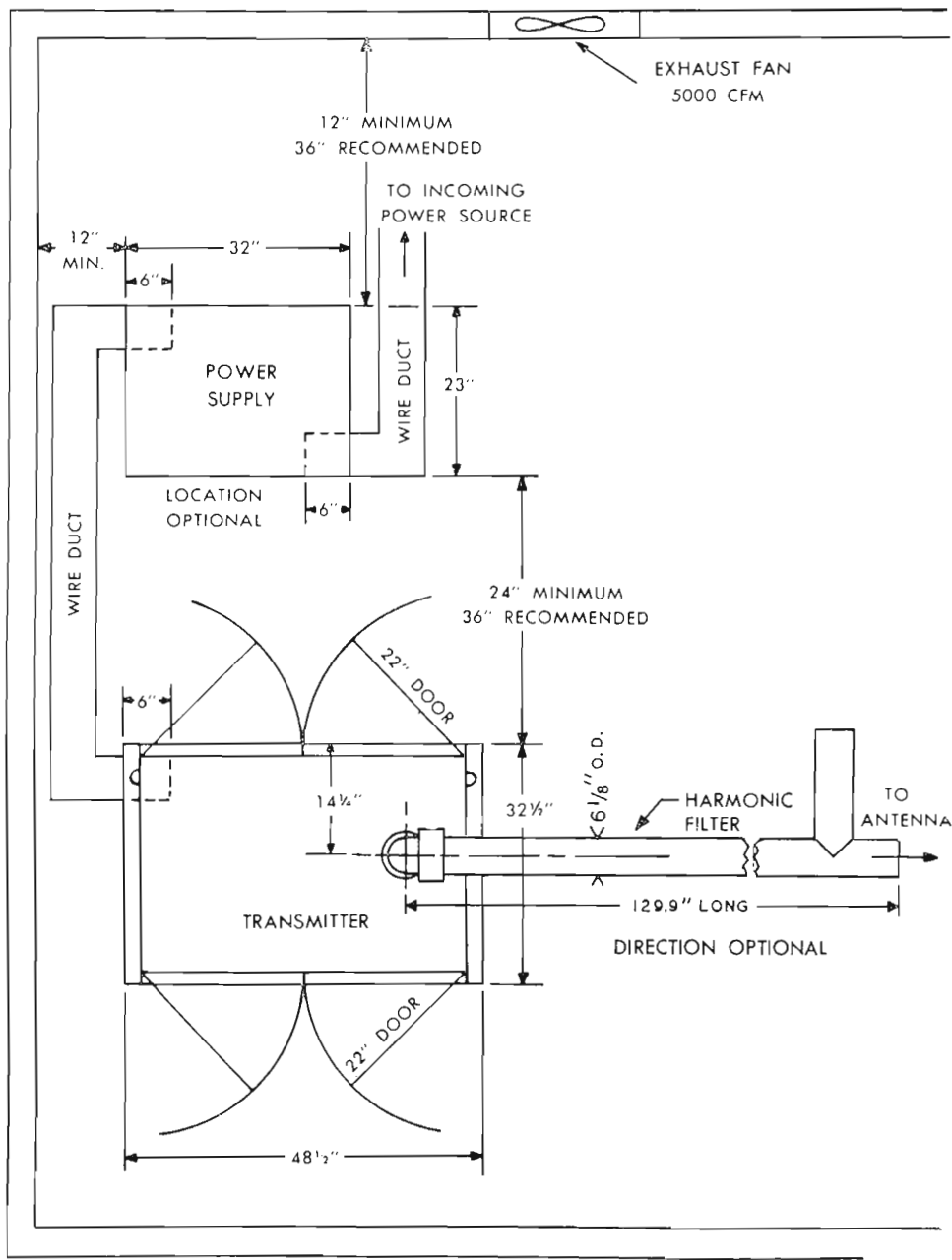


FIG. 7. Floor plan layout for BTF-20E transmitter.

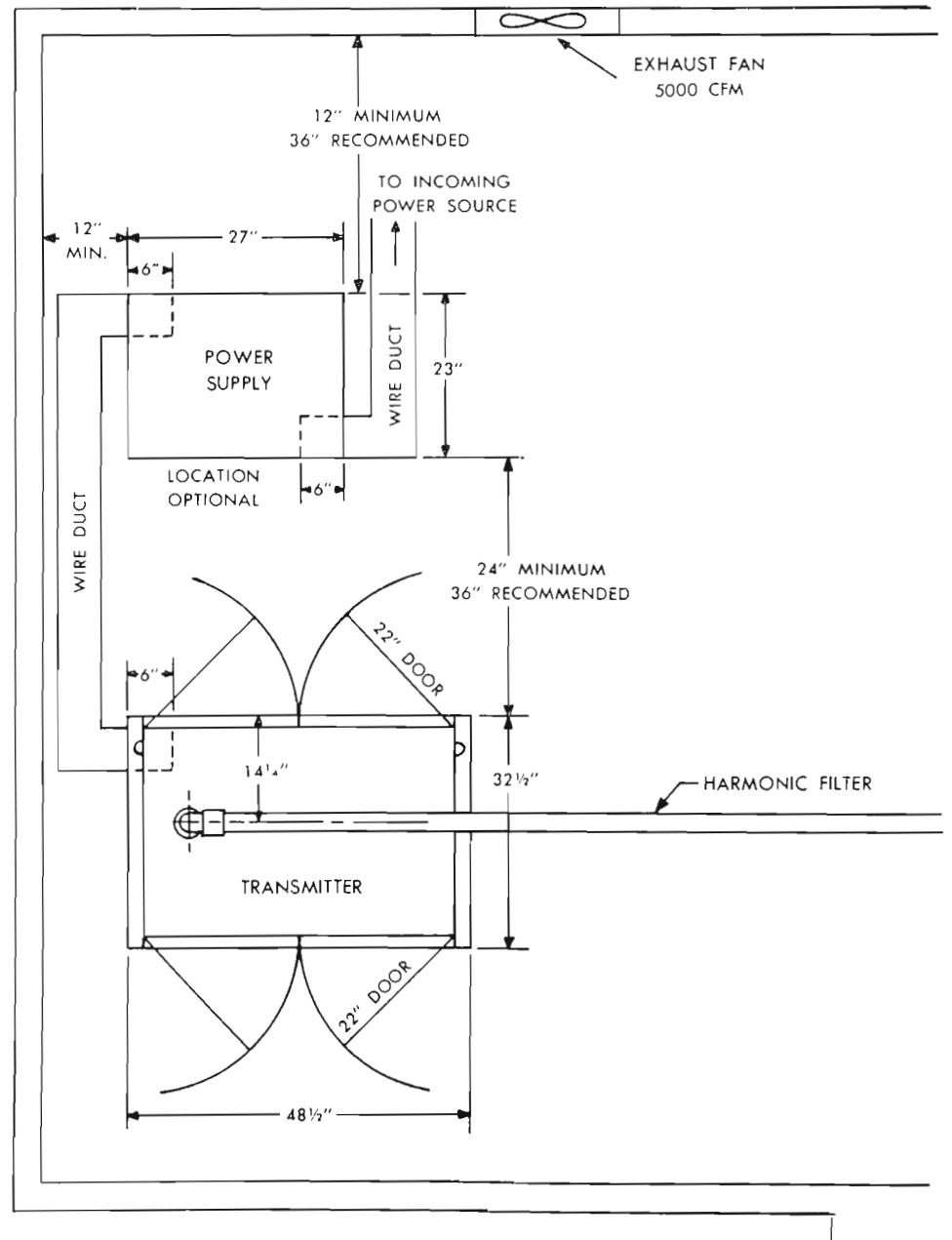


FIG. 8. Floor plan layout for BTF-5 or BTF-10E transmitters.

### Power Expandable Transmitters

Circuit simplicity as well as similarities between the five transmitters of the RCA full fidelity FM line can be seen by the block diagrams of Fig. 11. The 5 and 10-kilowatt transmitters (BTF-5E and BTF-10E) are actually lower power versions of the BTF-20E 20 kilowatt model brought about in each case by use of a lower power output tube, single driver stage and slightly smaller power supply. All other components, however, have the 20 kW rating, and there is space for inserting another driver tube and socket.

Thus the 5 and 10 kilowatt transmitters are both expandable to 20 kilowatt output with only minor modification and a slightly larger power supply.

As seen in the diagram the field model BTF-20E utilizes two paralleled 4CX250B intermediate amplifiers to drive the 4CX-15000A power amplifier. With the exciter modified for one-half frequency output and the parallel drivers changed to parallel doublers, this transmitter is ready to be combined with another identical transmitter, plus an exciter power splitter and an output diplexer to form the BTF-40E 40 kilowatt unit diagrammed.

### True FM Exciter

All these transmitters feature the RCA direct FM exciter with its recognized simplicity, stability and superior performance in stereo and multiplex operation. Very few tubes are used. RF stages are single tuned. Modulation is true reactance type FM resulting in audio response down to 30 cycles and below, and is achieved by long life capacitive diodes rather than by a reactance tube modulator. A buffer amplifier, frequency doubler (except for 40 kW transmitters) and power amplifier raise the output level to ten watts. There are no series or cascaded modulators, no critical modulation level adjustments. Precision AFC is maintained by a solid state magnetic amplifier control circuit.

### Simplified Tuning

For utmost tuning ease, simplified, single ended stages operating Class C follow the exciter in each unit. IPA stages employ pi-network input and output circuits tuned by variable vacuum capacitors. Final power amplifiers also operate Class C and utilize pi-network circuitry; tuning of these stages is accomplished by variable inductors operating at ground potential. Power output is controlled in each

transmitter by a motor driven variable transformer connected in the circuit that supplies screen voltages for the IPA and PA tubes.

### Conclusion

The RCA BTF-40E in achieving a full 40 kilowatt output will fill an important need for economical high power in FM broadcasting. Utilizing tried and proved components for this power level should greatly enhance the value and reliability of this transmitter for both remote and unattended operation. The BTF-40E rounds out the RCA full fidelity FM line of transmitters. All are designed for the ultimate in monaural, stereo and SCA performance.

All RCA FM transmitters are factory tuned. This includes frequency, power, and efficiency measurements that are made on each transmitter prior to shipment to the customer.

Fifteen to 20-year replacement parts service, unique with RCA, is available around the clock. RCA also has complete service availability for equipment installation, proof of performance, maintenance and emergency repairs.

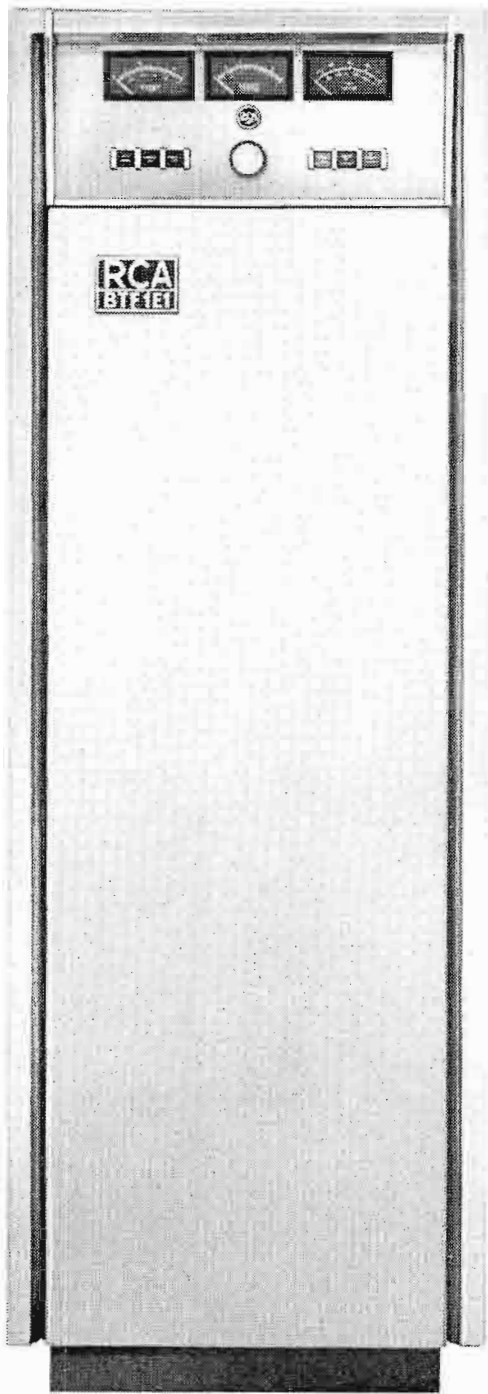


FIG. 9. BTF-1E 1 kW FM Transmitter.

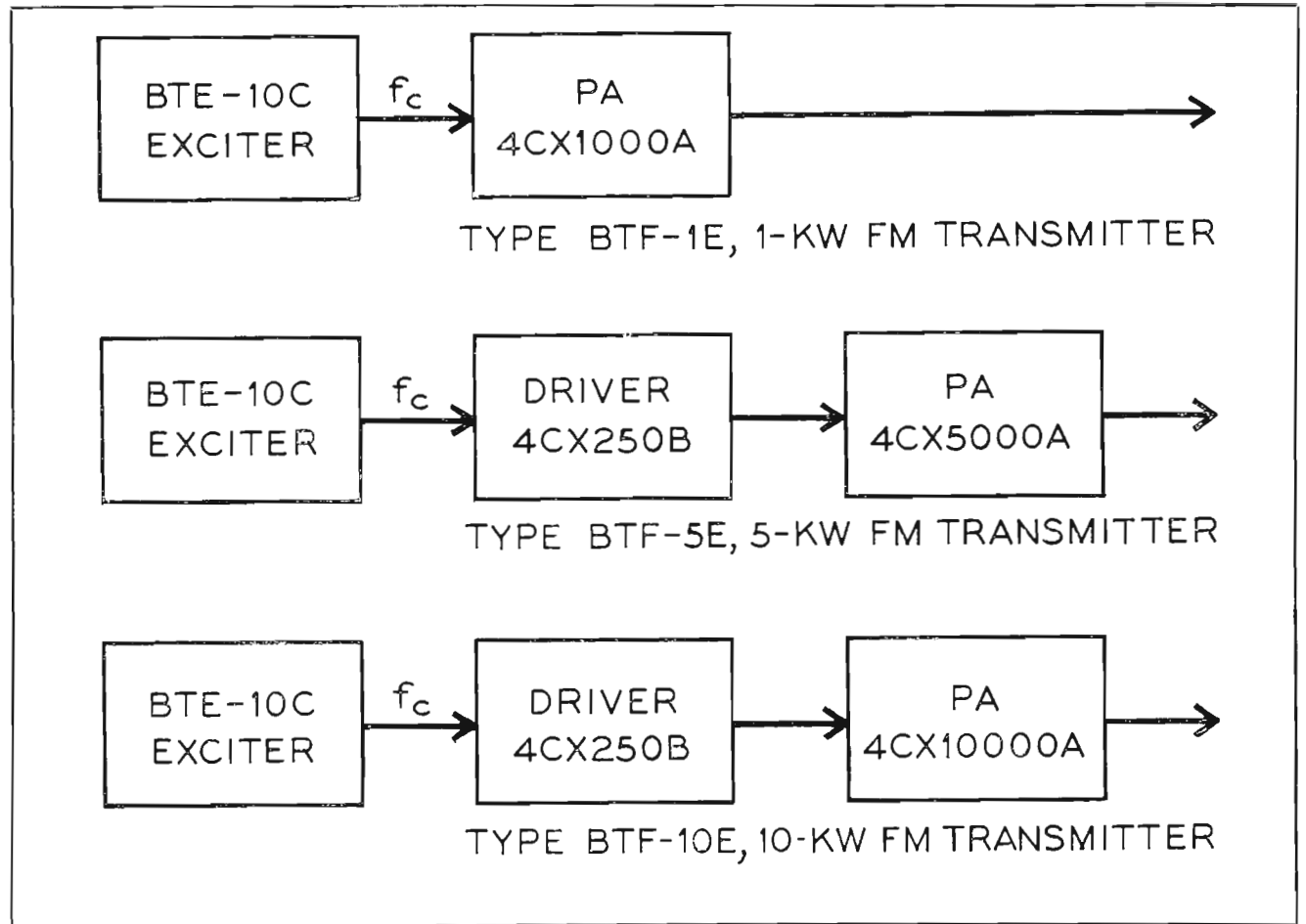


FIG. 11. RCA FM transmitters, with their circuit similarities, differ only in the type output tube used.

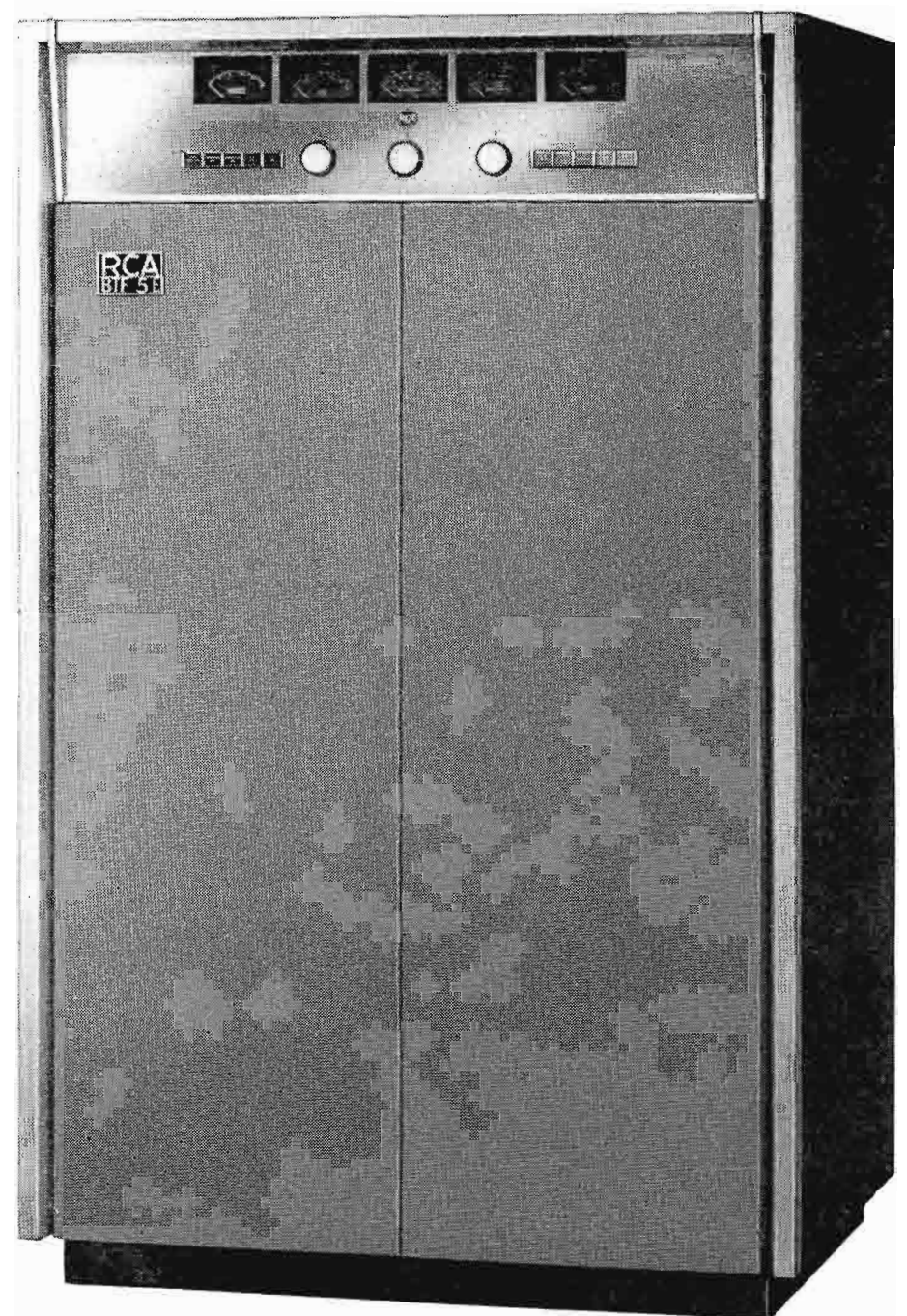


FIG. 10. BTF-5E 5 kW and BTF-10E 10 kW transmitters are in identical cabinets. Circuitry utilizes different output tubes for these transmitters as seen in block diagrams (Fig. 11).

# GIANT STEP TO MINIATURE MICROPHONES

Newly Developed BK-12A Packs Greater  
Sensitivity and Wider Frequency Response In a  
66 Percent Smaller Space

by R. A. REYNOLDS

*Broadcast Audio Products Merchandising*

How do you build broadcast quality performance into a microphone that's even smaller than the cigarette lighter in your car? The answer is in finding revolutionary new magnetic materials, micro-miniature production tools, modern machining methods and the other developments discussed in this article on broadcasting's new subminiature microphone — the RCA BK-12A.



FIG. 1. Subminiature BK-12A dynamic microphone.

ONE notable feat in the subminiaturization of acoustical devices is the production of the BK-12A—a true dynamic microphone of less than three-quarter inch volume.

Users of the popular BK-6B lavalier will appreciate this comparison: The BK-12A is one-third the size and weight, measuring only three-quarters inch diameter by one and one-half inch length and weighing only 20 grams. Yet, effective output level is five db greater and the frequency response range is wider than that of the BK-6B. Also, for the first time, the new mike features a completely replaceable cartridge assembly that permits full field reconditioning of a unit in a matter of minutes. The BK-12A also incorporates many other design features such as color neutrality and low reflection qualities, non-directional pickup pattern and tailored frequency response for proper speech reproduction when positioned on the chest of the user.

#### Personal Microphone Developments

Popularity of the lavalier, or personal microphone that can be worn by the performer is deeply rooted with the early beginnings in the development of personal microphones.

Transducers of this type were first developed by RCA for broadcast use more than a decade ago. In fact, the BK-1A dynamic microphone, introduced as early as 1950 can be considered a forerunner of RCA personal microphones because it was designed for hand held as well as stand operation. The first dynamic lavalier offered by RCA to the broadcast industry was the BK-6A introduced in 1955.\* One year later in 1956, industry was presented with the BK-6B miniature dynamic lavalier. Acceptance was immediate and its widespread popularity continues to this day.

\* Actually, the first RCA lavalier velocity microphone was the Type 30-A, introduced in 1934.



FIG. 2. Petite new BK-12A lavalier mike may be worn beneath clothing or exposed.

### The Role of Today's Personal Microphone

In recent years changes in program production techniques have placed critical demands upon the personal microphone.

Use of such a unit implies that it will be handled more often than not by non-technical people. Proper placement, therefore, can become a problem. Size and appearance of the microphone are also of prime importance especially to the television broadcaster. Maximum freedom of movement for the performer with minimum exposure of the pickup microphone are highly desirable.

While the requirements of a present day personal microphone are not very different, they are more exacting. The microphone must be of the smallest practical size; it should be least conspicuous to the viewer, and less critical to placement on the performer for proper operation. Of course, it should be comparable in performance with currently available microphones.

RCA's microphone subminiaturization program had over the years realized a high degree of success and, in producing the BK-1A, BK-6A and BK-6B microphones, provided a pool of knowledge and experience in setting up an engineering program for the design and development of the BK-12A.

Design objectives were established for the new subminiature microphone, all of which were either met or exceeded in the final BK-12A design. The new microphone was to be one-half the size and weight of the BK-6B; it was to be transformerless with voice coil impedance applicable to line use; construction was to be exceptionally rugged to withstand the misuse it might be subjected to, due to its small size; and was to incorporate a set of accessory tie clip and lanyard holders in keeping with its small size.

Early investigations into reducing the size and weight of the BK-6B were carried out at the RCA Laboratories in Princeton, New Jersey, under the direction of Dr. H. F. Olson, resulting in a small pressure microphone with performance closely paralleling the BK-6B. But most importantly, this research pointed the way toward a practical subminiature microphone design.

### Microphone Miniaturization

Problems related to reducing the physical size of the new microphone were evident even in the early stages of development: Smaller diaphragm area resulted in less acoustical force exerted upon it; shrinking of case volume adversely affected proper low frequency response; and smaller voice coil and magnet structure size resulted in lower sensitivity.

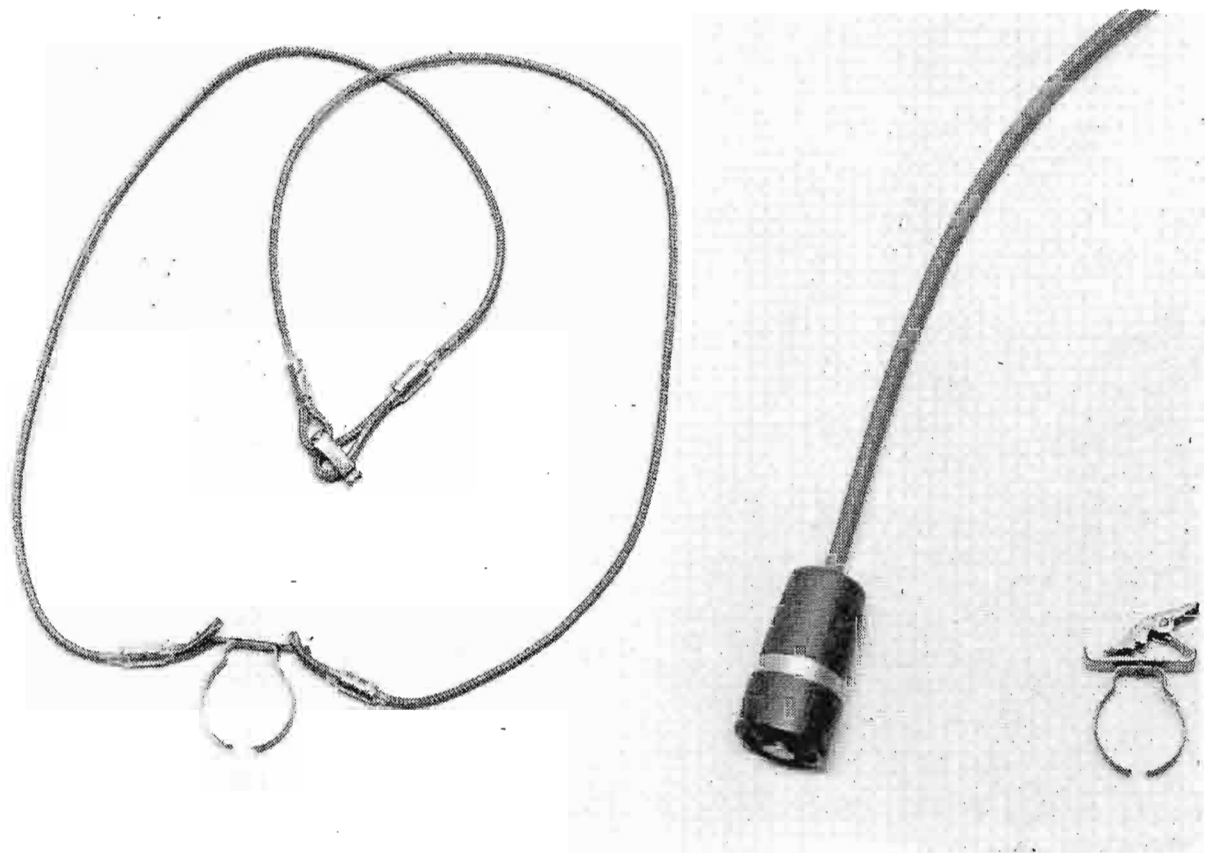


FIG. 3. BK-12A shown with tie clip accessory (right) and lanyard having clip fastener.

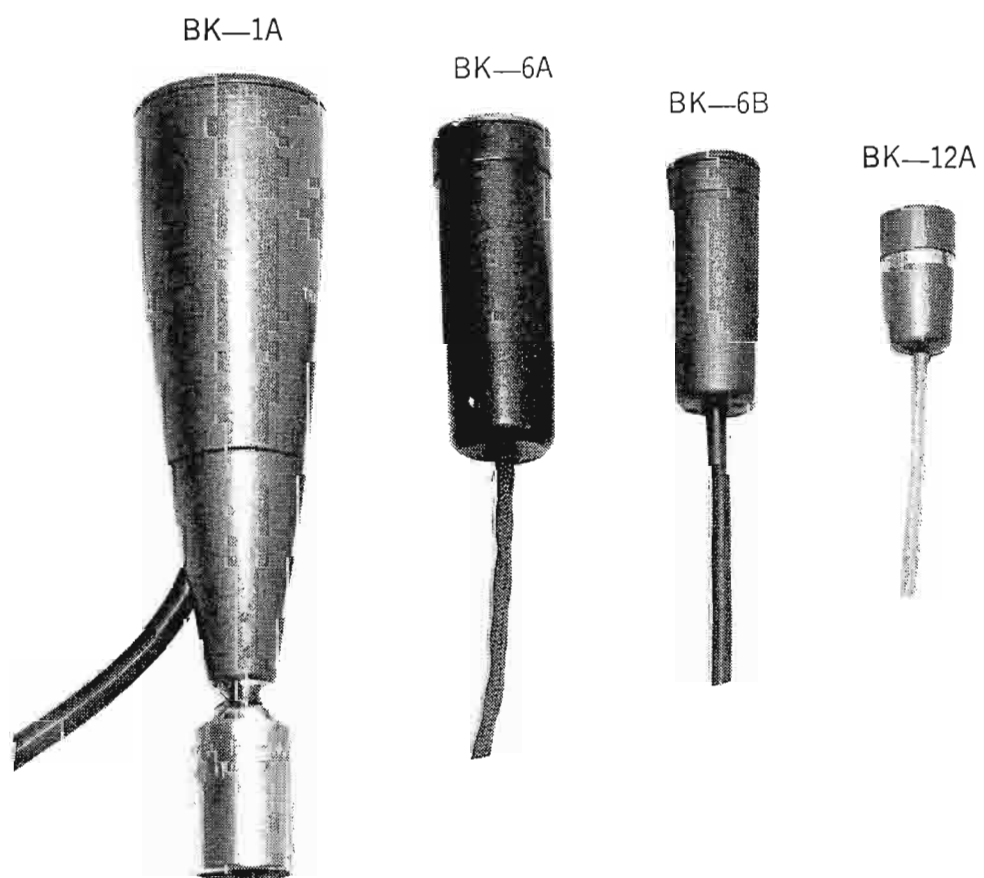


FIG. 4. RCA family of personal microphones illustrates striking advances in subminiaturization. New BK-12A is shown at right.

These problems were overcome in the following ways: (1) through the use of improved magnetic materials which allowed the development of a very small magnet structure of high flux density; (2) through the use of ultra-fine wire winding techniques, plus the development of a voice coil winding of maximum length; (3) through the use of a low frequency equalizing tube of optimum size which provided proper response in the small case.

Miniaturization placed additional burdens upon microphone production facilities as well as outside suppliers. Due to the very small size and close tolerances of the microphone parts, surgical cleanliness was required. All persons involved in supplying or assembling parts had to be trained to meet requirements, for the smallest particle of foreign material could not be tolerated. Lower costs of modern machining methods

enabled fabrication of small parts which would have been prohibitively expensive a few years ago.

#### New Subminiature Microphone Cable

The new subminiature microphone required a cable of appropriate size which was developed with the cooperation of a cable manufacturer. The resulting product was a highly flexible cable of small diameter using very fine cadmium copper conductors and a new braided shield structure of conducting textile and cadmium copper.

#### BK-12A Design Features

The finalized design of the new subminiature dynamic microphone exceeded the original objectives. It is one-third the size and weight of the BK-6B microphone. It measures three-quarters of an inch in

diameter by one and one-half inches in length and weighs only 20 grams. The BK-6B is 15/16 inch in diameter by two and 9/16 inches in length and weighs 60 grams.

Due to its light weight the new personal microphone is easily supported by the accessory tie clip holder which fastens to shirt or lapel. When the tie clip holder is impractical to use, the lavalier holder may be used to suspend the microphone about the neck. A cable clip is supplied for securing the microphone cable to the wearer's clothing, providing strain relief as well as isolation of noise due to cable movement. The small size and the choice of case and cable colors allow the BK-12A to be worn less conspicuously about the person. The colors were chosen for their relative neutrality with respect to various clothing colors, and for low reflective

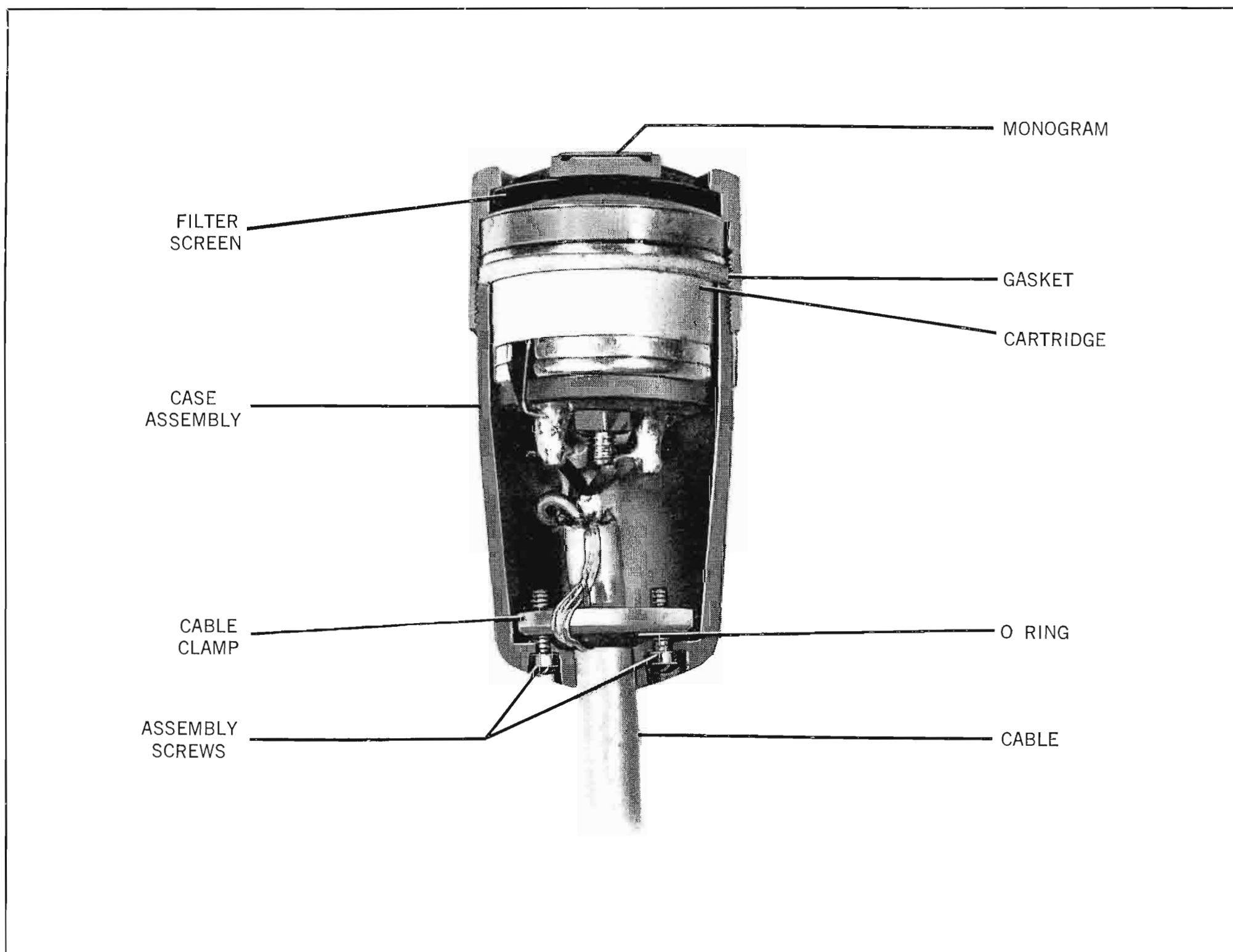


FIG. 5. Cross-section view showing details of BK-12A construction.

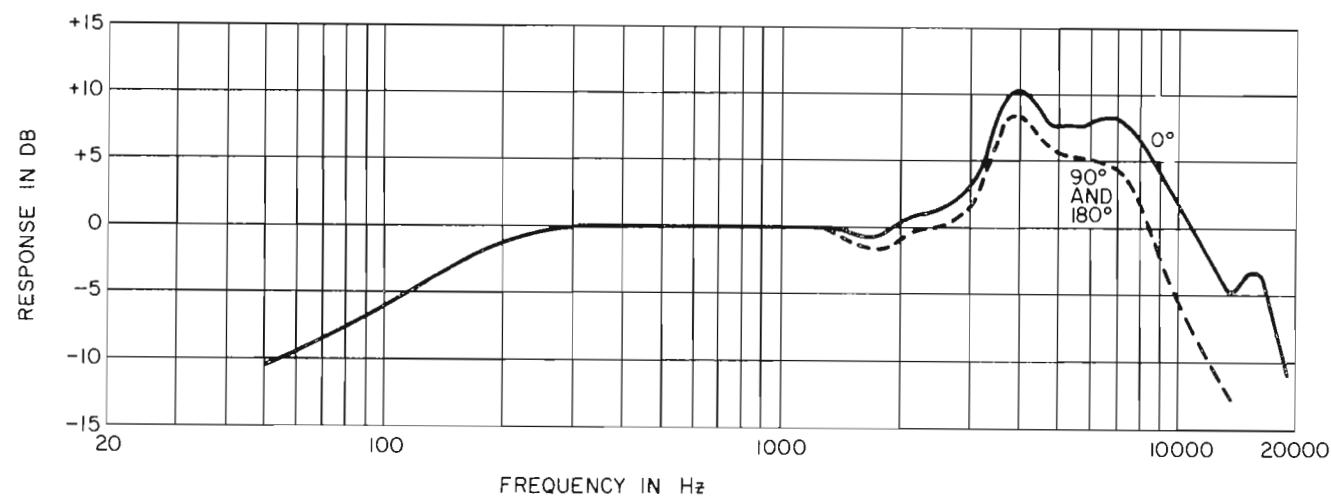


FIG. 6. BK-12A frequency response curve.

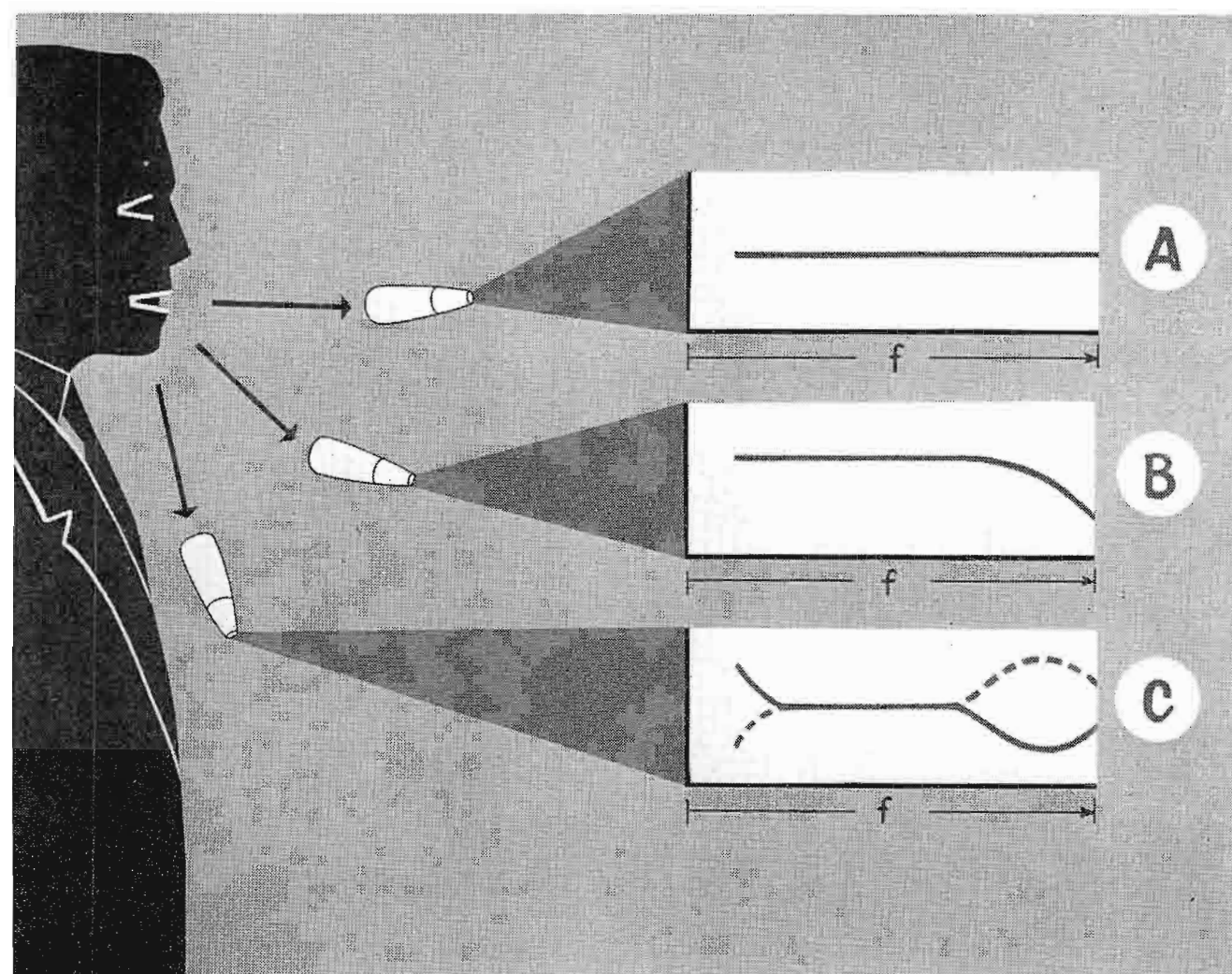


FIG. 7. Diagram showing how position of personal microphone affects its response to speaker's voice frequencies. (See text)

qualities. The microphone reflects no more light than the hand when observed in a television scene. The small size is also responsible for an essentially non-directional pickup pattern in the speech range. Thus, errors in microphone placement are less critical. The smooth bronze epoxy finish of the microphone case also reduces noise generated by movement of the microphone across the wearer's clothing.

Since a transformer is not used in the BK-12A, magnetic hum sensitivity is 8 db lower than in the BK-6B microphone. The line impedance voice coil may be used with unloaded preamplifier inputs

ranging from 30 to 250 ohms without changing microphone impedance. A stainless steel acoustical screen located just under the case cap is virtually dirt proof and water-proof due to its micron size mesh. A completely replaceable cartridge assembly is featured, making it possible to fully recondition a unit in the field.

#### Tailored Frequency Response

The frequency response of the BK-12A is tailored to compensate for the effect the various positions would otherwise have on the frequency response of the user's voice. For those who may not understand the reasons for response tailoring in a

personal microphone, a brief review of the subject is given.

The chart of Fig. 7 depicts three locations of the same microphone in respect to the wearer. For purposes of illustration two things are assumed: 1. The user does not move and speaks directly ahead; and 2, the microphone has perfectly flat frequency response.

In the first position (A), the microphone is directly on the axis of the user's mouth and all frequencies are faithfully reproduced. In the second microphone position (B), the microphone is at an angle off the axis of the mouth and the high frequency response is beginning to fall off. In the third microphone position (C), against the man's chest, sound is reaching the microphone at an even greater angle off axis, and there is greater drop-off of the higher frequencies. However, two additional changes also have taken place which affect the microphone's reproduction. One, a so called shadow effect, apparently the result of the presence of the man's chin in the sound path has caused the very high frequencies to start rising. Secondly, acoustical radiation from the man's chest has begun to reinforce the lower frequencies and a rising response can be seen at this end of the spectrum. An ideal microphone for this type application, then, is one where the response characteristics are the inverse of the response of the microphone at the C position. The desired response is indicated by the dotted line. Notice the similarity of this curve to the frequency response curve of the BK-12A microphone seen in Fig. 6.

#### Conclusions

The development of the BK-12A sub-miniature microphone represents a complete utilization of modern materials and manufacturing techniques in transducer design, and marks a new level of achievement in miniaturization of broadcast quality microphones.

The primary advantages of the microphone lie in its small size, light weight and neutral finish which allows it to be easily concealed in a person's clothing. A non-directional pickup pattern reduces the possibility of placement error. Its tailored frequency response provides superior speech balance. Dirt and moisture protection as well as rugged construction insure a long life expectancy.

This subminiature dynamic microphone will find application wherever the necessity of speech pickup exists, whether through a desire to conceal the device or to provide freedom of movement.

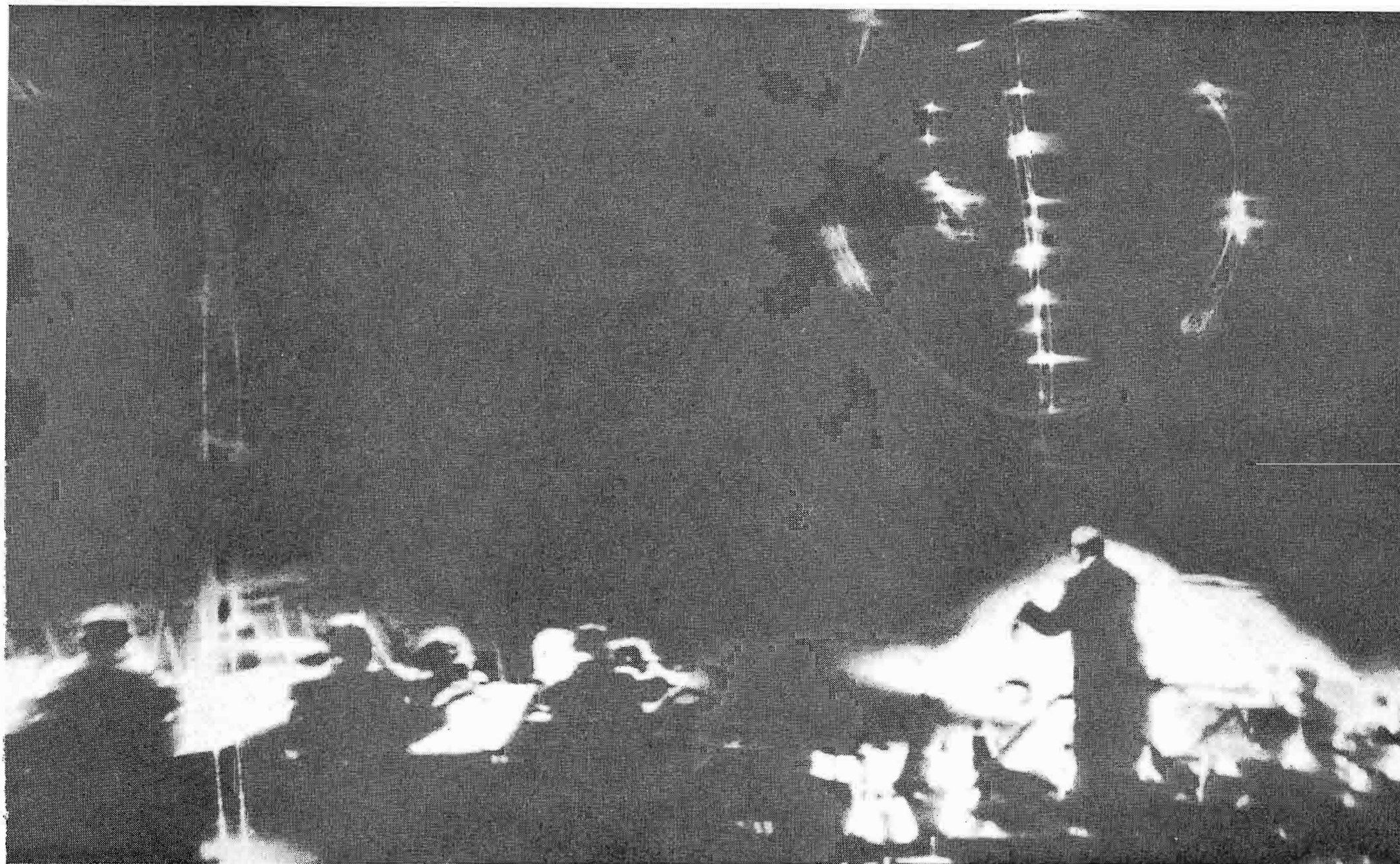


## THERE'S A NEW SPIRIT...

"Listen to me!" it says, "things are happening! Good things!" Things that make the public turn the dial—to your station if you're quality-ready. For today's FM audience is a selective group, largely of mature tastes and preferences, with the means to enjoy them. And they want quality—all the way.

Today there are more FM radio frequencies, more good high-fidelity receivers for listeners to choose from, and RCA system-matched "New Look" equipment to put your station out front in quality . . . New full-fidelity FM transmitters designed to transmit stereophonic signals, an SCA multiplex sub-channel; also new transistorized tape recorders and turntables; consolettes to meet NAB standards for highest performance and programming efficiency.





## IN TODAY'S FM OPERATIONS!

Also the newest in FM antennas—a Single, Circularly Polarized Radiator—that does the work of two conventional antennas.

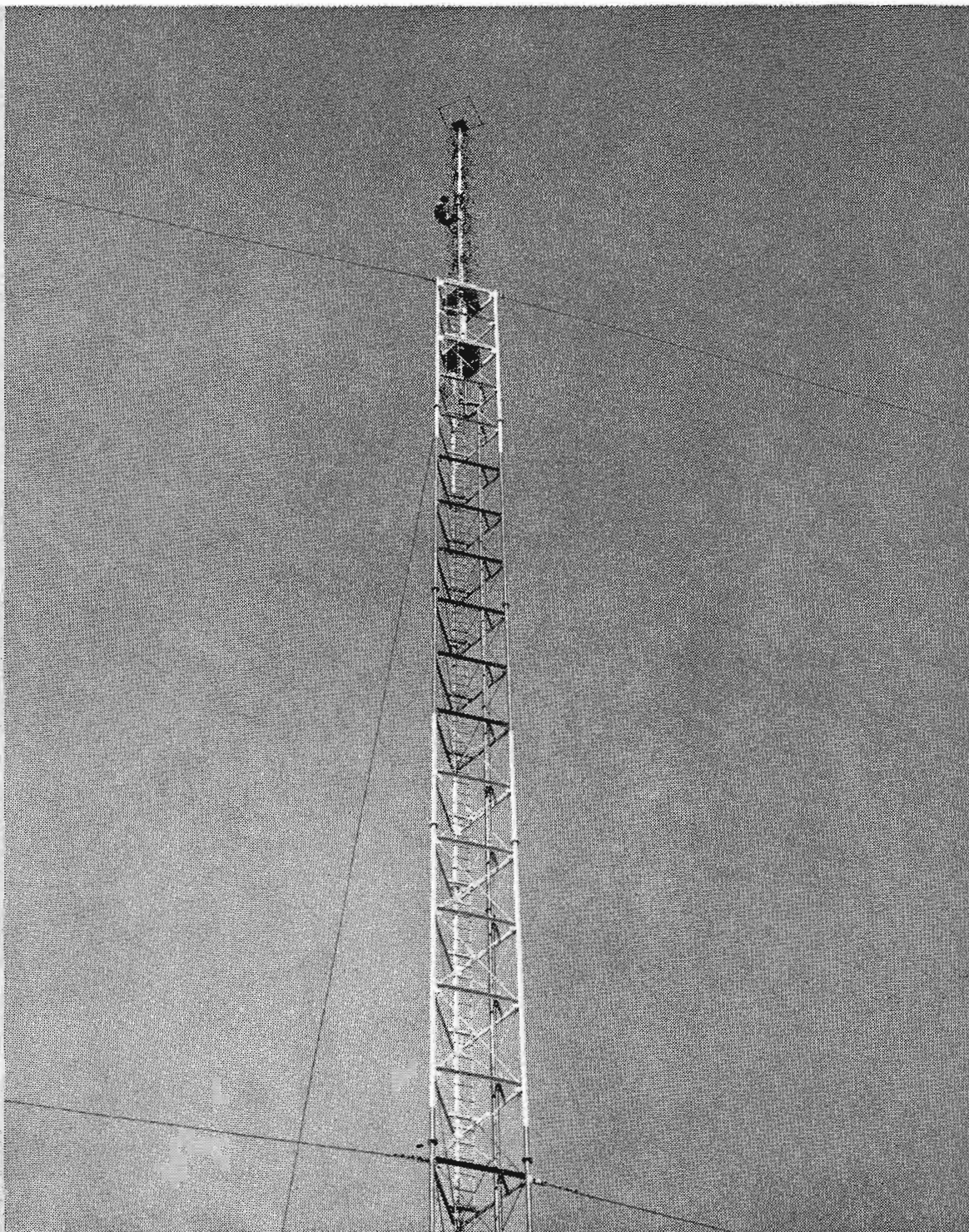
Your RCA Broadcast Representative will be glad to tell you all about these fine new opportunities for moving ahead in quality. Or for particulars, write RCA Broadcast and Television Equipment, Building 15-5, Camden, N. J.



**The Most Trusted Name in Electronics**

# RCA SERVICE

keeps all your  
AM, FM, TV  
equipment  
in top  
condition!



*Antenna System Measurements*

## TAKE ADVANTAGE OF THE FOLLOWING SERVICES OFFERED BY RCA:

- Video Tape Recorder Service • TV Camera Overhaul • TV Transmitter Overhaul
- Installation Supervision • Microphone and Pick-Up Repairs • Transmitter Performance Measurements • Antenna Inspection Measurements • Console Repairs • Microwave Service
- TV Projector Service • Custom Fabrication • Teletypewriter Maintenance

Your audience demands a superior signal which requires top performance from all your station equipment. RCA Broadcast Service is planned to assure you of meeting this objective. More than 30 years in the broadcast industry have provided a background of solid service experience. This is the type of protection broadcasters have relied on for years, the kind of protection you can count on . . . contract or per-call . . .

from the experts in the service business, RCA Service Company. To guard performance of all your equipment . . . simply telephone one of the following field offices: Atlanta (phone 355-6110), Chicago (WE 9-6117), Phila. (HO 7-3300), Hollywood (OL 4-0880). Or contact Technical Products Service, RCA Service Company, A Division of Radio Corporation of America, Bldg. 203-1, Camden, N.J. 08101.



The Most Trusted Name in Electronics

**RCA**  
**BC-7**

*Closest to Custom in a Production Console!*



## **RCA Transistorized Console** for Dual-Channel AM/TV and FM Stereo

Take a good look at this smart new model. Here's that "custom" appearance to satisfy the proudest management; "custom" quality and flexibility to please the most discriminating engineers...all in a production-model!

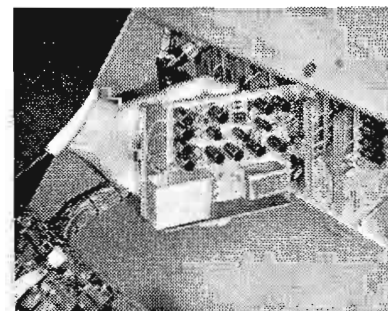
**CUSTOM STYLING**—Striking new lines in blue and silver bring a color accent to control rooms. Color-coded operating controls are engineered to avoid errors. Only 39" long, it is compact and self-contained...to satisfy new or existing arrangements.

**CUSTOM QUALITY**—The BC-7A is fully transistorized for long-term reliability. All amplifiers have input and output transformers...precise impedance matching for both program and monitoring circuits. You get quality stereo monitoring (10 watts out-

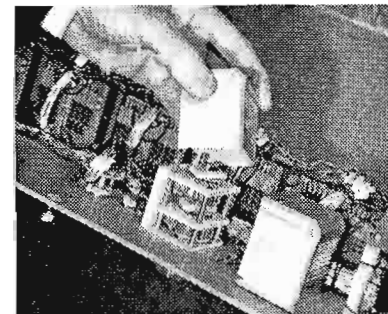
put), quality gain controls, quality leaf-type key switches on all program circuits.

**CUSTOM FLEXIBILITY**—You have interchangeable plug-in modules...preamplifiers, isolation/balancing units, program amplifiers, monitoring amplifiers, cue amplifier and power supply—all in one self-contained unit. You get three-mode operation...selector switch to instantaneously convert from dual channel, parallel or stereo operation.

We can't name them all here, but we believe you will agree that this is the kind of customized styling, quality, and flexibility you want. Let your Broadcast Representative show you all the features that make this console your best buy. Or write RCA, Broadcast and Television Equipment, Bldg. 15-5, Camden, N. J.



Plug-in flexibility... preamplifiers for low-level sources... isolation/balancing units for high level sources.



High quality mixers...ganged step-type attenuators when in stereo... individual step-type when in dual channel use.



**THE MOST TRUSTED NAME IN ELECTRONICS**

RCA  
NEW  
LOOK